



Rex

PX-0432-ANT

Surface-mounted wall light IP54 Rex LED 6.6W 3000K ON-OFF Urban grey 680

TECHNICAL FEATURES

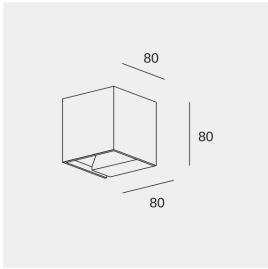

IP54 IK08



Luminaire total power : 6.6W

Real lumens : 244

Nominal lumens : 680

Real lm/W : 37

Lens / reflector angle : FLOOD 81°

Structure material : Aluminium

Structure finish : Urban grey

Diffuser material : Glass

Diffuser finish : Transparent

Voltage / frequency : 100-240V ~ 50/60Hz

Dimming protocol : ON-OFF

Power Factor : 0.50

Useful life : 36.000h L70B30

Warranty : 5 Years

Easily recyclable luminaire

LUMINOTECHNIC FEATURES

CRI: 80

MacAdam steps: 3

Photobiological risk: RG1

UGR

UGR crosswise: 20.7

UGR lengthwise: 14.3

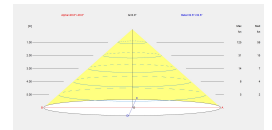
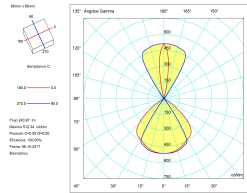

Lampholder	Quantity	Light source power (W)	Correlated Colour Temperature (CCT)
LED	1	5.2W	3000K

LOGISTICS

Net weight (kg): 0.42

Packaged weight (kg): 0.46

Packaging: 85mm x 85mm x 85mm



27 Un



Luminaire

Code PX-0432-ANT
 Name APLIQUE FORLIGHT LEDS
Measur.
 Code CL116A17F329G
 Name APLIQUE FORLIGHT LEDS

Luminaire Flux	243.97 lm	Luminaire Power	6.64 W	Efficacy	36.74 lm/W	Efficiency	100.00%
Lamps Flux	243.97 lm	Maximum value	512.34 cd/klm	Position	C=0.00 G=0.00	CG	Double Symmetrical
Rectangular Luminaire		Length	80 mm	Width	80 mm	Height	80 mm
Rectangular Luminous Area		Length	45 mm	Width	75 mm	Height	0 mm
Horizontal Luminous Area	0.003375 m2	Emitting area on Plane 180°		Emitting area on Plane 270°		Emitting area on Plane 0°	0.000000 m2
Emitting area on Plane 0°	0.000000 m2	Emitting area on Plane 90°	0.000000 m2	Glare area at 76°			0.000816 m2
Coordinate system	CG	Symmetry Type	Double Symmetrical	Maximum Gamma Angle	180	Measurement Flux	243.97 lm
Date	06-10-2017	Measurement Flux					
Measurement Distance	0.00						
Operator	Asselum T2	Source Voltage [V]		Source current [A]		Photocell	
Temperature	25.00 °C						
Humidity	60.00 %						
Notes							

Line	Code	Luminaire Lamps Name	Flux [lm]	Pow. [W]	Q.ty
	PX-0432-ANT	PX-0432-ANT	243.97	6.64	1
C.I.E.	79 98 99 81 100	D DIN 5040	B61		
F UTE	0.81 B + 0.19 T	B NBN	BZ 1		

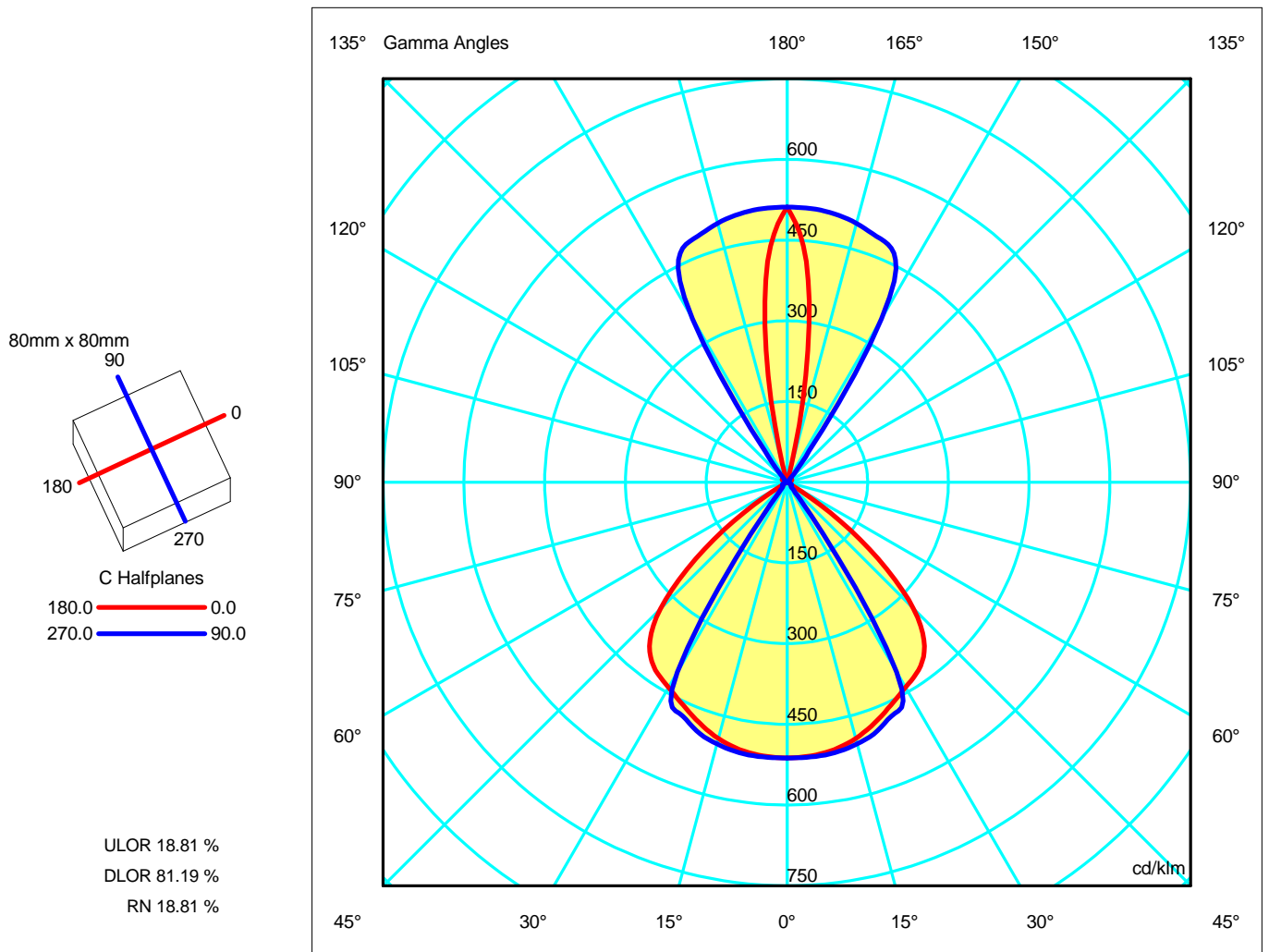



Luminaire

Code PX-0432-ANT
 Name APLIQUE FORLIGHT LEDS

Measur.

Code CL116A17F329G
 Name APLIQUE FORLIGHT LEDS

Luminaire Flux	243.97 lm	Luminaire Power	6.64 W	Efficacy	36.74 lm/W	Efficiency	100.00%
Lamps Flux	243.97 lm	Maximum value	512.34 cd/klm	Position	C=0.00 G=0.00	CG	Double Symmetrical

Luminous Intensity Table cd/klm Table 1/1

	C 0.00	C 15.00	C 30.00	C 45.00	C 60.00	C 75.00	C 90.00
G 0.0	512.34	512.34	512.34	512.34	512.34	512.34	512.34
G 5.0	510.52	510.64	510.98	511.44	511.87	512.16	512.27
G 10.0	504.36	505.06	506.65	508.20	509.41	510.10	510.31
G 15.0	492.85	494.57	497.46	500.04	502.01	503.15	503.37
G 20.0	475.85	478.38	481.97	486.71	491.41	492.13	491.43
G 25.0	456.84	458.92	462.32	467.55	471.76	471.84	473.80
G 30.0	440.16	440.70	440.18	442.24	445.53	430.20	407.43
G 35.0	425.92	426.12	418.10	420.72	344.96	166.13	117.32
G 40.0	397.13	401.19	397.28	315.12	83.31	32.75	18.72
G 45.0	332.51	344.77	352.81	113.85	18.41	11.28	10.36
G 50.0	221.64	241.83	246.56	24.93	10.07	10.10	10.18
G 55.0	97.33	117.84	114.53	9.58	9.67	9.89	10.09
G 60.0	3.24	16.38	27.82	8.93	9.23	9.50	9.73
G 65.0	3.09	4.07	5.19	6.71	8.40	8.70	8.75
G 70.0	2.94	3.62	4.44	5.51	6.90	6.79	6.74
G 75.0	2.79	3.14	3.65	4.36	5.00	4.85	4.25
G 80.0	2.52	2.75	3.07	3.30	3.53	3.23	2.42
G 85.0	2.25	2.37	2.53	2.52	2.57	2.57	1.88
G 90.0	1.98	1.98	1.97	2.07	2.07	2.21	2.07
G 95.0	1.24	1.24	2.09	2.23	2.27	2.26	1.34
G100.0	1.76	1.87	2.30	2.52	2.49	2.09	1.35
G105.0	3.62	3.81	3.12	2.78	2.70	1.88	1.64
G110.0	6.93	6.16	4.57	3.05	2.89	2.34	2.37
G115.0	9.69	8.51	6.46	3.38	3.09	3.07	3.56
G120.0	10.24	10.42	6.86	3.83	3.31	3.68	4.37
G125.0	10.07	9.94	6.51	4.98	3.55	4.05	4.78
G130.0	9.90	9.75	9.97	6.10	3.85	4.39	5.05
G135.0	9.73	10.17	9.48	6.51	4.07	4.70	5.32
G140.0	7.80	8.30	7.67	5.83	3.34	7.27	8.36
G145.0	5.88	6.40	5.87	4.02	5.79	54.42	71.60
G150.0	3.95	2.81	3.82	5.38	7.30	204.01	351.72
G155.0	3.53	4.25	5.32	6.71	69.88	313.97	469.88
G160.0	5.09	5.81	6.77	28.99	182.60	381.14	486.54
G165.0	10.89	25.68	74.81	168.54	301.96	435.83	498.44
G170.0	201.06	216.27	260.39	328.42	408.25	477.25	506.68
G175.0	411.97	417.83	434.52	458.41	483.66	503.15	511.11
G180.0	511.61	511.61	511.61	511.61	511.61	511.61	511.61

Luminaire
 Code PX-0432-ANT
 Name APLIQUE FORLIGHT LEDS
Measur.
 Code CL116A17F329G
 Name APLIQUE FORLIGHT LEDS

Luminaire Flux	243.97 lm	Luminaire Power	6.64 W	Efficacy	36.74 lm/W	Efficiency	100.00%
Lamps Flux	243.97 lm	Maximum value	512.34 cd/klm	Position	C=0.00 G=0.00	CG	Double Symmetrical

80mm x 80mm

C Halfplanes

180.0 ——— 0.0
 270.0 ——— 90.0

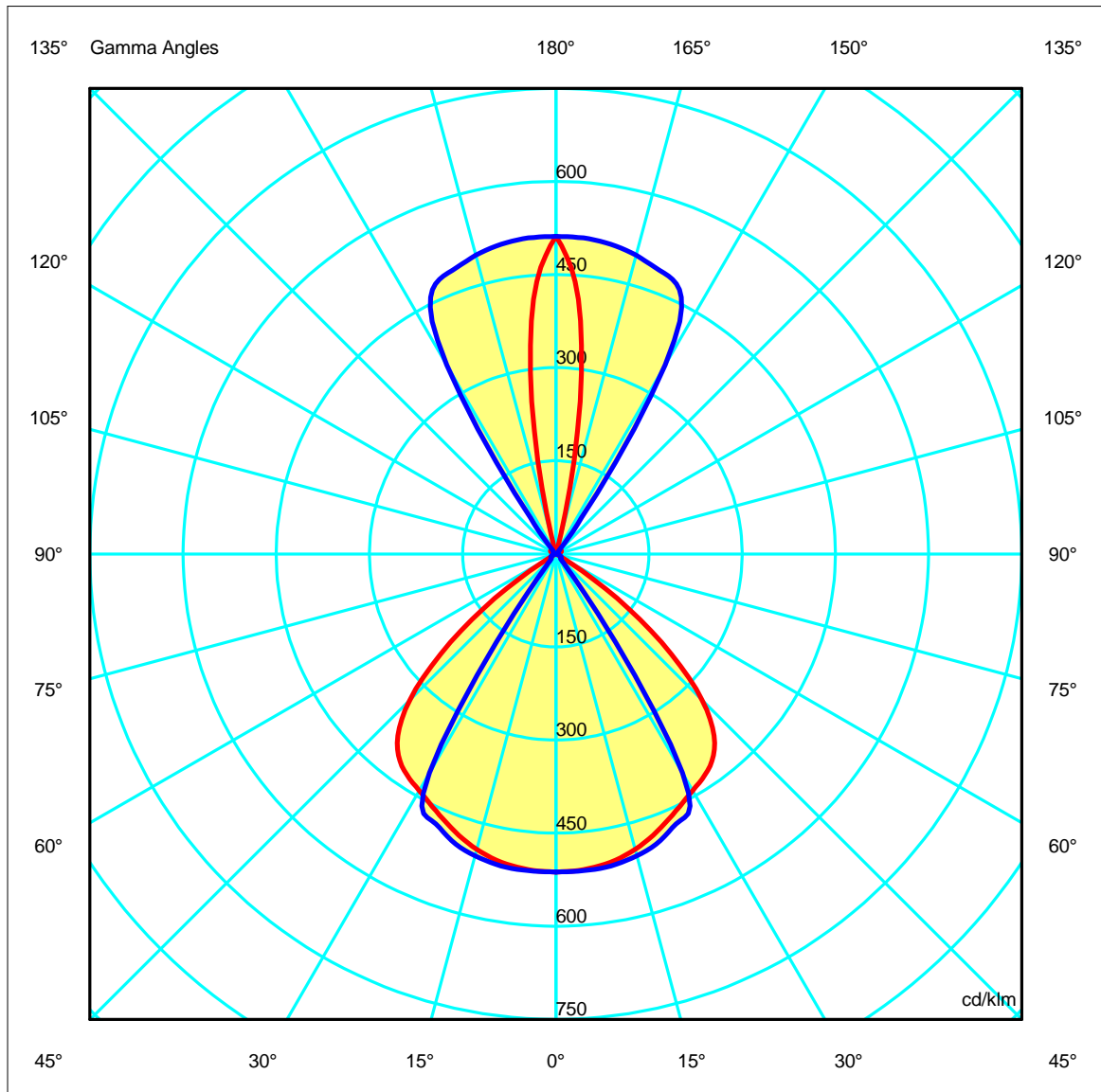
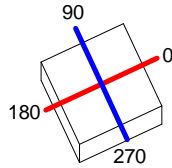

Luminaire

Code PX-0432-ANT
 Name APLIQUE FORLIGHT LEDS
Measurement
 Code CL116A17F329G
 Name APLIQUE FORLIGHT LEDS

Luminaire Flux	243.97 lm	Luminaire Power	6.64 W	Efficacy	36.74 lm/W	Efficiency	100.00%
Lamps Flux	243.97 lm	Maximum value	512.34 cd/klm	Position	C=0.00 G=0.00	CG	Double Symmetrical

Width at 50.00 % of Max Intensity

H[m]	1.00	2.00	3.00	4.00	5.00	H[m]	1.00	2.00	3.00	4.00	5.00
OA	1.13	2.27	3.40	4.53	5.67	OC	0.64	1.28	1.92	2.56	3.20
OB	1.13	2.27	3.40	4.53	5.67	OD	0.64	1.28	1.92	2.56	3.20

		Luminous Intensities [cd/klm]									
	0	5	15	25	35	45	55	65	75	85	
OA	125.00	124.55	120.24	111.45	103.91	81.12	23.75	0.75	0.68	0.55	
OB	125.00	124.55	120.24	111.45	103.91	81.12	23.75	0.75	0.68	0.55	
OC	125.00	124.98	122.81	115.59	28.62	2.53	2.46	2.13	1.04	0.46	
OD	125.00	124.98	122.81	115.59	28.62	2.53	2.46	2.13	1.04	0.46	

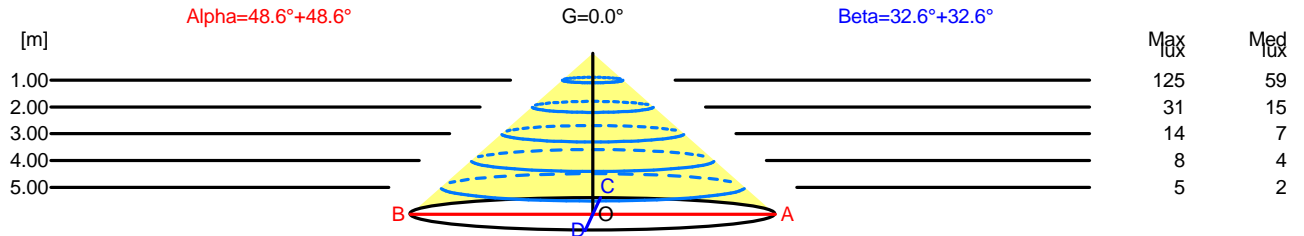

H[m]	D[m]	Max lux	Med lux	Alpha=48.6°+48.6°	G=0.0	
1.00	2.27	125	59			
2.00	4.53	31	15			
3.00	6.80	14	7			
4.00	9.07	8	4			
5.00	11.33	5	2			

H[m]	D[m]	Max lux	Med lux	Beta=32.6°+32.6°	G=0.0	
1.00	1.28	125	59			
2.00	2.56	31	15			
3.00	3.84	14	7			
4.00	5.13	8	4			
5.00	6.41	5	2			



Luminaire

Code PX-0432-ANT
Name APLIQUE FORLIGHT LEDS

Measurerm.

Code CL116A17F329G
Name APLIQUE FORLIGHT LEDS

Luminaire Flux	243.97 lm	Luminaire Power	6.64 W	Efficacy	36.74 lm/W	Efficiency	100.00%
Lamps Flux	243.97 lm	Maximum value	512.34 cd/klm	Position	C=0.00 G=0.00	CG	Double Symmetrical

UGR
S = 0.250

Reflectancies										
Ceiling/Cavity	0.7	0.7	0.5	0.5	0.3	0.7	0.7	0.5	0.5	0.3
Walls	0.5	0.3	0.5	0.3	0.3	0.5	0.3	0.5	0.3	0.3
WorkingPlane	0.2	0.2	0.2	0.2	0.2	0.2	0.2	0.2	0.2	0.2
RoomDimensions	ViewedCrosswise					ViewedEndwise				
x=2H y=2H	21.1	21.9	21.7	22.4	23.0	14.0	14.8	14.5	15.2	15.8
x=2H y=3H	20.9	21.6	21.5	22.2	22.8	13.9	14.6	14.5	15.2	15.7
x=2H y=4H	20.8	21.5	21.4	22.0	22.7	13.9	14.5	14.5	15.1	15.7
x=2H y=6H	20.7	21.3	21.3	21.9	22.6	13.9	14.5	14.5	15.0	15.7
x=2H y=8H	20.7	21.2	21.3	21.8	22.5	13.8	14.4	14.5	15.0	15.7
x=2H y=12H	20.6	21.2	21.3	21.8	22.4	13.8	14.4	14.5	15.0	15.6
x=4H y=2H	20.8	21.5	21.4	22.0	22.7	14.2	14.9	14.8	15.4	16.0
x=4H y=3H	20.6	21.2	21.3	21.8	22.4	14.2	14.7	14.8	15.3	16.0
x=4H y=4H	20.5	21.0	21.2	21.6	22.3	14.2	14.7	14.9	15.3	16.0
x=4H y=6H	20.4	20.8	21.1	21.5	22.2	14.2	14.6	14.9	15.3	16.0
x=4H y=8H	20.4	20.7	21.1	21.4	22.2	14.2	14.6	14.9	15.3	16.0
x=4H y=12H	20.3	20.7	21.0	21.3	22.1	14.3	14.6	15.0	15.3	16.1
x=8H y=4H	20.4	20.7	21.1	21.4	22.2	14.1	14.5	14.8	15.1	15.9
x=8H y=6H	20.3	20.6	21.0	21.3	22.1	14.2	14.5	14.9	15.2	16.0
x=8H y=8H	20.2	20.5	21.0	21.2	22.0	14.2	14.5	15.0	15.2	16.0
x=8H y=12H	20.2	20.4	20.9	21.1	22.0	14.3	14.5	15.1	15.3	16.1
x=12H y=4H	20.3	20.6	21.0	21.3	22.1	14.1	14.4	14.8	15.1	15.9
x=12H y=6H	20.2	20.5	21.0	21.2	22.0	14.2	14.4	14.9	15.1	16.0
x=12H y=8H	20.2	20.4	20.9	21.1	22.0	14.2	14.4	15.0	15.2	16.0

Luminaire

Code PX-0432-ANT
 Name APLIQUE FORLIGHT LEDS

Measur.

Code CL116A17F329G
 Name APLIQUE FORLIGHT LEDS

Luminaire Flux	243.97 lm	Luminaire Power	6.64 W	Efficacy	36.74 lm/W	Efficiency	100.00%
Lamps Flux	243.97 lm	Maximum value	512.34 cd/klm	Position	C=0.00 G=0.00	CG	Double Symmetrical

80mm x 80mm

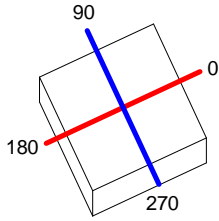

C Halfplanes

180.0 ———— 0.0
 270.0 ———— 90.0

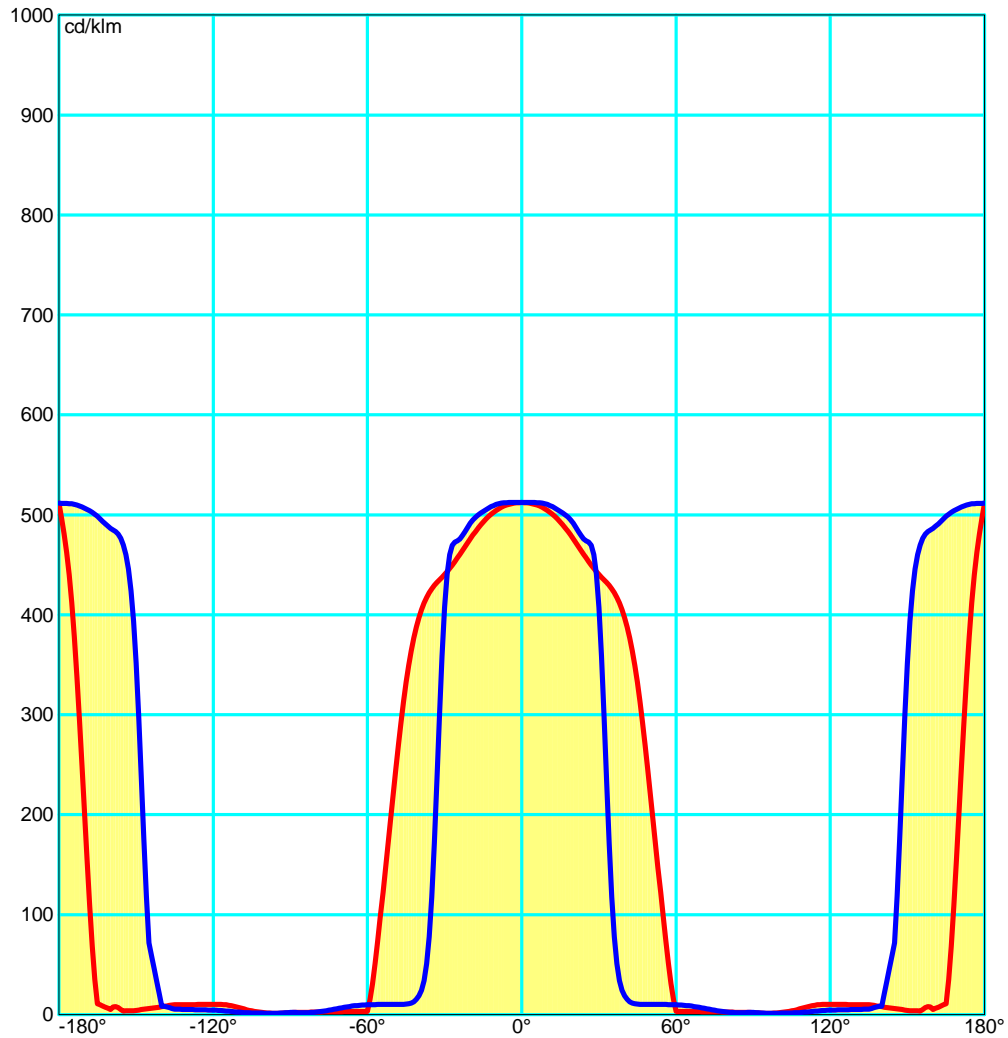

Luminaire
 Code PX-0432-ANT
 Name APLIQUE FORLIGHT LEDS
Measur.
 Code CL116A17F329G
 Name APLIQUE FORLIGHT LEDS

Luminaire Flux	243.97 lm	Luminaire Power	6.64 W	Efficacy	36.74 lm/W	Efficiency	100.00%
Lamps Flux	243.97 lm	Maximum value	512.34 cd/klm	Position	C=0.00 G=0.00	CG	Double Symmetrical

Luminance

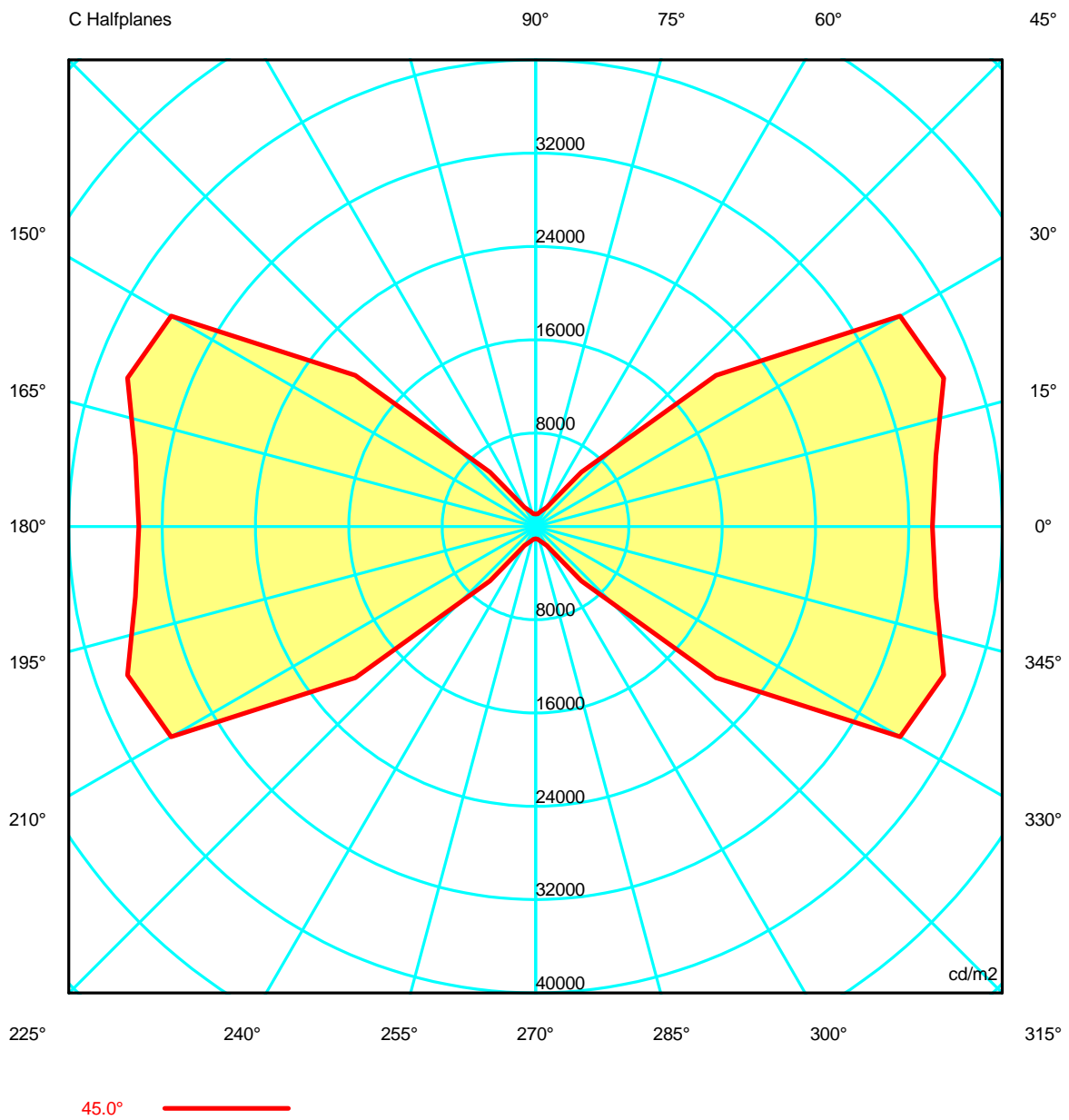



Luminaire

Code PX-0432-ANT
Name APLIQUE FORLIGHT LEDS

Measurerm.

Code CL116A17F329G
Name APLIQUE FORLIGHT LEDS

Luminaire Flux	243.97 lm	Luminaire Power	6.64 W	Efficacy	36.74 lm/W	Efficiency	100.00%
Lamps Flux	243.97 lm	Maximum value	512.34 cd/klm	Position	C=0.00 G=0.00	CG	Double Symmetrical

Luminance cd/m2 Table 1/3

	C 0.00	C 10.00	C 20.00	C 30.00	C 40.00	C 50.00	C 60.00	C 70.00	C 80.00	C 90.00	C 100.00	C 110.00	C 120.00
G 0.0	37035.81	37035.81	37035.81	37035.81	37035.81	37035.81	37035.81	37035.81	37035.81	37035.81	37035.81	37035.81	37035.81
G 5.0	37044.94	37049.23	37060.16	37078.66	37100.44	37122.63	37142.82	37158.68	37167.96	37172.12	37167.96	37158.68	37142.82
G 10.0	37021.47	37049.17	37106.41	37189.39	37267.64	37335.83	37391.67	37430.18	37450.27	37458.05	37450.27	37430.18	37391.67
G 15.0	36883.64	36960.19	37078.43	37228.88	37362.79	37476.26	37569.39	37634.62	37665.40	37671.07	37665.40	37634.62	37569.39
G 20.0	36605.84	36728.85	36881.60	37076.44	37309.75	37579.04	37802.29	37865.25	37842.64	37804.13	37842.64	37865.25	37802.29
G 25.0	36437.52	36541.24	36677.49	36875.18	37144.59	37433.83	37627.87	37632.22	37663.65	37790.68	37663.65	37632.22	37627.87
G 30.0	36740.62	36781.15	36772.40	36742.22	36803.52	37081.33	37188.25	36475.45	35295.64	34008.33	35295.64	36475.45	37188.25
G 35.0	37586.42	37721.74	37368.02	36895.91	37049.92	36181.93	30441.13	19444.73	11895.28	10353.48	11895.28	19444.73	30441.13
G 40.0	37474.83	37739.82	37936.54	37489.55	34279.06	22551.17	7861.78	3220.62	2849.14	1766.86	2849.14	3220.62	7861.78
G 45.0	33992.78	34828.41	37223.93	36068.17	20170.30	6087.57	1882.24	1396.47	1122.12	1059.20	1122.12	1396.47	1882.24
G 50.0	24925.04	25772.62	29355.64	27727.60	10610.61	2246.13	1132.15	1134.66	1138.92	1144.93	1138.92	1134.66	1132.15
G 55.0	12266.34	13853.05	15903.36	14434.38	5187.19	1211.31	1218.12	1237.21	1255.08	1271.72	1255.08	1237.21	1218.12
G 60.0	468.92	1623.19	3238.75	4022.10	2212.69	1305.50	1334.75	1360.70	1384.71	1406.76	1384.71	1360.70	1334.75
G 65.0	529.09	639.65	755.59	887.18	1049.71	1255.77	1436.59	1471.25	1491.30	1496.77	1491.30	1471.25	1436.59
G 70.0	622.04	714.97	820.12	938.83	1074.61	1276.28	1457.71	1442.81	1432.03	1425.38	1432.03	1442.81	1457.71
G 75.0	780.07	842.24	919.28	1020.29	1146.67	1290.16	1395.60	1389.85	1305.25	1187.86	1305.25	1389.85	1395.60
G 80.0	1050.16	1109.66	1191.09	1279.70	1342.34	1414.05	1467.76	1415.86	1248.04	1006.13	1248.04	1415.86	1467.76
G 85.0	1868.14	1926.16	2015.25	2096.90	2093.22	2105.64	2134.14	2181.42	1995.77	1558.04	1995.77	2181.42	2134.14
G 90.0	0.00	0.00	0.00	0.00	0.00	0.00	0.00	0.00	0.00	0.00	0.00	0.00	0.00



Luminaire

Code PX-0432-ANT
Name APLIQUE FORLIGHT LEDS

Measurerm.

Code CL116A17F329G
Name APLIQUE FORLIGHT LEDS

Luminaire Flux	243.97 lm	Luminaire Power	6.64 W	Efficacy	36.74 lm/W	Efficiency	100.00%
Lamps Flux	243.97 lm	Maximum value	512.34 cd/klm	Position	C=0.00 G=0.00	CG	Double Symmetrical

Luminance cd/m2 Table 2/3

	C 130.00	C 140.00	C 150.00	C 160.00	C 170.00	C 180.00	C 190.00	C 200.00	C 210.00	C 220.00	C 230.00	C 240.00	C 250.00
G 0.0	37035.81	37035.81	37035.81	37035.81	37035.81	37035.81	37035.81	37035.81	37035.81	37035.81	37035.81	37035.81	37035.81
G 5.0	37122.63	37100.44	37078.66	37060.16	37049.23	37044.94	37049.23	37060.16	37078.66	37100.44	37122.63	37142.82	37158.68
G 10.0	37335.83	37267.64	37189.39	37106.41	37049.17	37021.47	37049.17	37106.41	37189.39	37267.64	37335.83	37391.67	37430.18
G 15.0	37476.26	37362.79	37228.88	37078.43	36960.19	36883.64	36960.19	37078.43	37228.88	37362.79	37476.26	37569.39	37634.62
G 20.0	37579.04	37309.75	37076.44	36881.60	36728.85	36605.84	36728.85	36881.60	37076.44	37309.75	37579.04	37802.29	37865.25
G 25.0	37433.83	37144.59	36875.18	36677.49	36541.24	36437.52	36541.24	36677.49	36875.18	37144.59	37433.83	37627.87	37632.22
G 30.0	37081.33	36803.52	36742.22	36772.40	36781.15	36740.62	36781.15	36772.40	36742.22	36803.52	37081.33	37188.25	36475.45
G 35.0	36181.93	37049.92	36895.91	37368.02	37721.74	37586.42	37721.74	37368.02	36895.91	37049.92	36181.93	30441.13	19444.73
G 40.0	22551.17	34279.06	37489.55	37936.54	37739.82	37474.83	37739.82	37936.54	37489.55	34279.06	22551.17	7861.78	3220.62
G 45.0	6087.57	20170.30	36068.17	37223.93	34828.41	33992.78	34828.41	37223.93	36068.17	20170.30	6087.57	1882.24	1396.47
G 50.0	2246.13	10610.61	27727.60	29355.64	25772.62	24925.04	25772.62	29355.64	27727.60	10610.61	2246.13	1132.15	1134.66
G 55.0	1211.31	5187.19	14434.38	15903.36	13853.05	12266.34	13853.05	15903.36	14434.38	5187.19	1211.31	1218.12	1237.21
G 60.0	1305.50	2212.69	4022.10	3238.75	1623.19	468.92	1623.19	3238.75	4022.10	2212.69	1305.50	1334.75	1360.70
G 65.0	1255.77	1049.71	887.18	755.59	639.65	529.09	639.65	755.59	887.18	1049.71	1255.77	1436.59	1471.25
G 70.0	1276.28	1074.61	938.83	820.12	714.97	622.04	714.97	820.12	938.83	1074.61	1276.28	1457.71	1442.81
G 75.0	1290.16	1146.67	1020.29	919.28	842.24	780.07	842.24	919.28	1020.29	1146.67	1290.16	1395.60	1389.85
G 80.0	1414.05	1342.34	1279.70	1191.09	1109.66	1050.16	1109.66	1191.09	1279.70	1342.34	1414.05	1467.76	1415.86
G 85.0	2105.64	2093.22	2096.90	2015.25	1926.16	1868.14	1926.16	2015.25	2096.90	2093.22	2105.64	2134.14	2181.42
G 90.0	0.00	0.00	0.00	0.00	0.00	0.00	0.00	0.00	0.00	0.00	0.00	0.00	0.00



Luminaire

Code PX-0432-ANT
 Name APLIQUE FORLIGHT LEDS
Measur.
 Code CL116A17F329G
 Name APLIQUE FORLIGHT LEDS

Luminaire Flux	243.97 lm	Luminaire Power	6.64 W	Efficacy	36.74 lm/W	Efficiency	100.00%
Lamps Flux	243.97 lm	Maximum value	512.34 cd/klm	Position	C=0.00 G=0.00	CG	Double Symmetrical

Luminance cd/m2 Table 3/3

	C 260.00	C 270.00	C 280.00	C 290.00	C 300.00	C 310.00	C 320.00	C 330.00	C 340.00	C 350.00
G 0.0	37035.81	37035.81	37035.81	37035.81	37035.81	37035.81	37035.81	37035.81	37035.81	37035.81
G 5.0	37167.96	37172.12	37167.96	37158.68	37142.82	37122.63	37100.44	37078.66	37060.16	37049.23
G 10.0	37450.27	37458.05	37450.27	37430.18	37391.67	37335.83	37267.64	37189.39	37106.41	37049.17
G 15.0	37665.40	37671.07	37665.40	37634.62	37569.39	37476.26	37362.79	37228.88	37078.43	36960.19
G 20.0	37842.64	37804.13	37842.64	37865.25	37802.29	37579.04	37309.75	37076.44	36881.60	36728.85
G 25.0	37663.65	37790.68	37663.65	37632.22	37627.87	37433.83	37144.59	36875.18	36677.49	36541.24
G 30.0	35295.64	34008.33	35295.64	36475.45	37188.25	37081.33	36803.52	36742.22	36772.40	36781.15
G 35.0	11895.28	10353.48	11895.28	19444.73	30441.13	36181.93	37049.92	36895.91	37368.02	37721.74
G 40.0	2849.14	1766.86	2849.14	3220.62	7861.78	22551.17	34279.06	37489.55	37936.54	37739.82
G 45.0	1122.12	1059.20	1122.12	1396.47	1882.24	6087.57	20170.30	36068.17	37223.93	34828.41
G 50.0	1138.92	1144.93	1138.92	1134.66	1132.15	2246.13	10610.61	27727.60	29355.64	25772.62
G 55.0	1255.08	1271.72	1255.08	1237.21	1218.12	1211.31	5187.19	14434.38	15903.36	13853.05
G 60.0	1384.71	1406.76	1384.71	1360.70	1334.75	1305.50	2212.69	4022.10	3238.75	1623.19
G 65.0	1491.30	1496.77	1491.30	1471.25	1436.59	1255.77	1049.71	887.18	755.59	639.65
G 70.0	1432.03	1425.38	1432.03	1442.81	1457.71	1276.28	1074.61	938.83	820.12	714.97
G 75.0	1305.25	1187.86	1305.25	1389.85	1395.60	1290.16	1146.67	1020.29	919.28	842.24
G 80.0	1248.04	1006.13	1248.04	1415.86	1467.76	1414.05	1342.34	1279.70	1191.09	1109.66
G 85.0	1995.77	1558.04	1995.77	2181.42	2134.14	2105.64	2093.22	2096.90	2015.25	1926.16
G 90.0	0.00	0.00	0.00	0.00	0.00	0.00	0.00	0.00	0.00	0.00

Luminaire
 Code PX-0432-ANT
 Name APLIQUE FORLIGHT LEDS
Measur.
 Code CL116A17F329G
 Name APLIQUE FORLIGHT LEDS

Luminaire Flux	243.97 lm	Luminaire Power	6.64 W	Efficacy	36.74 lm/W	Efficiency	100.00%
Lamps Flux	243.97 lm	Maximum value	512.34 cd/klm	Position	C=0.00 G=0.00	CG	Double Symmetrical

PERCENTAGE ISOCANDLES

Projection: SLI 10.9 Tight Tilting Angle:0°

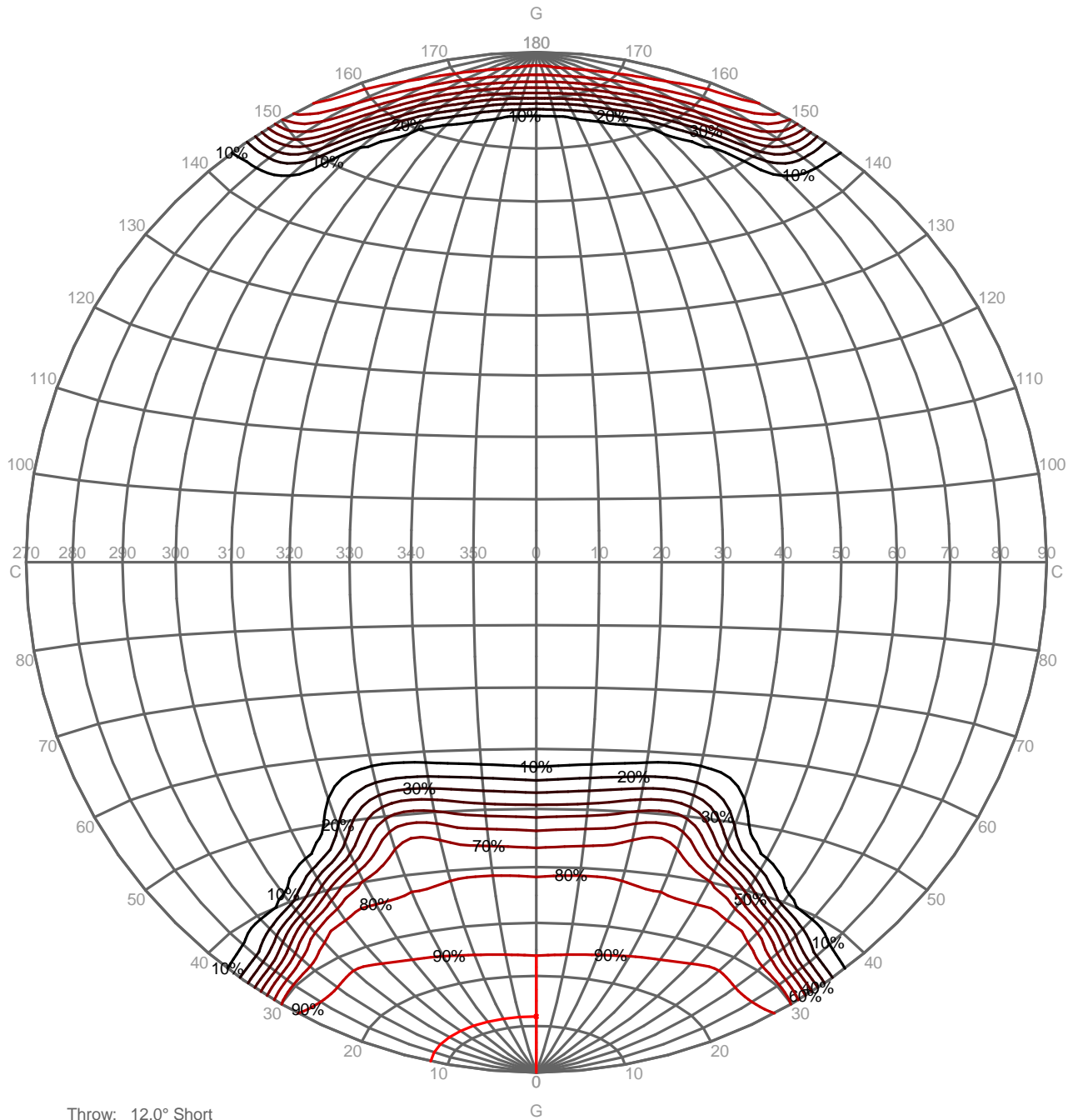

Luminaire
 Code PX-0432-ANT
 Name APLIQUE FORLIGHT LEDS
Measur.
 Code CL116A17F329G
 Name APLIQUE FORLIGHT LEDS

Luminaire Flux	243.97 lm	Luminaire Power	6.64 W	Efficacy	36.74 lm/W	Efficiency	100.00%
Lamps Flux	243.97 lm	Maximum value	512.34 cd/klm	Position	C=0.00 G=0.00	CG	Double Symmetrical

Isolux (Floor)

Luminaire position X=0.00m Y=0.00m Z=2.50m

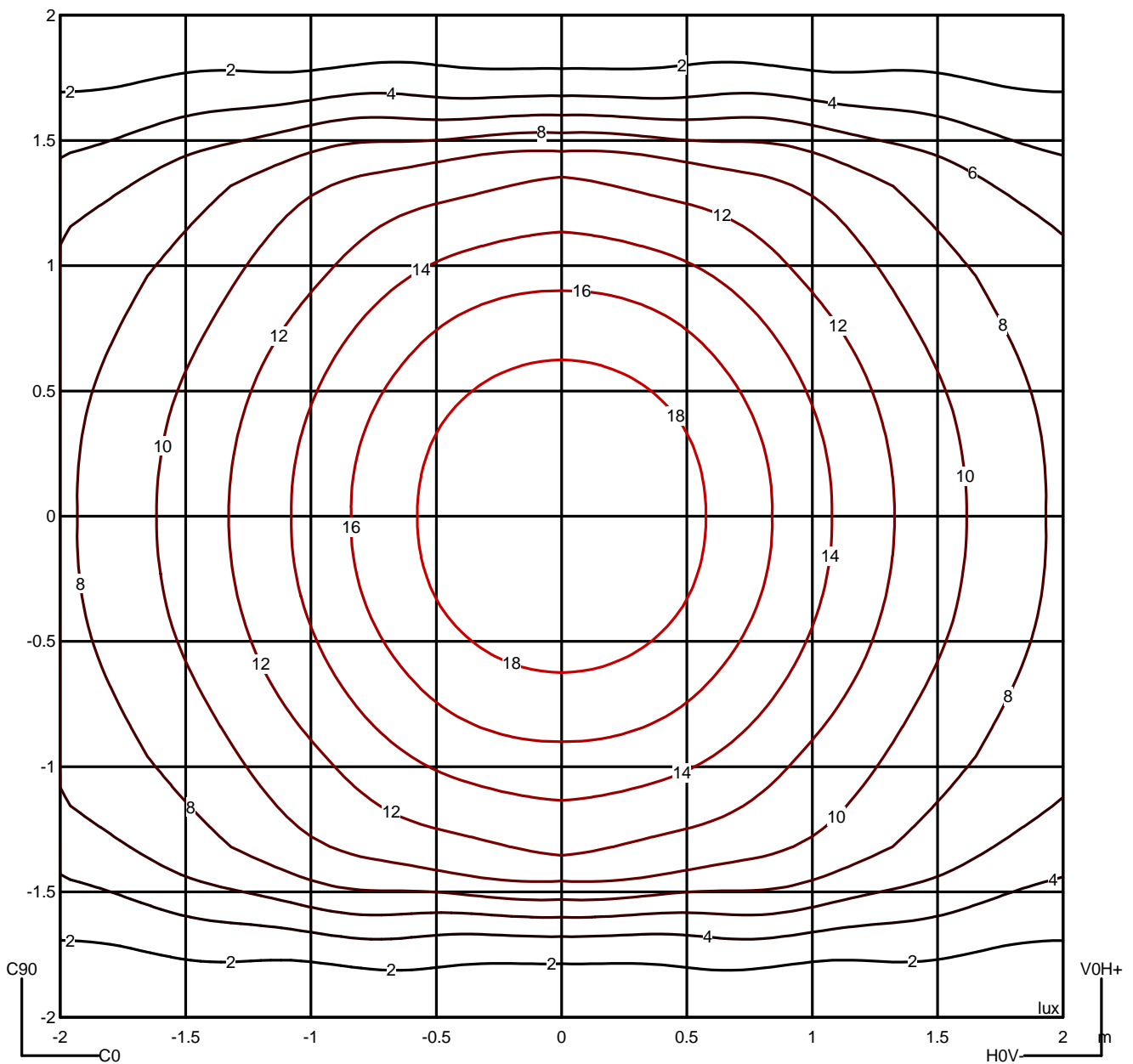

Luminaire

Code PX-0432-ANT
Name APLIQUE FORLIGHT LEDS

Measur.

Code CL116A17F329G
Name APLIQUE FORLIGHT LEDS

Luminaire Flux	243.97 lm	Luminaire Power	6.64 W	Efficacy	36.74 lm/W	Efficiency	100.00%
Lamps Flux	243.97 lm	Maximum value	512.34 cd/klm	Position	C=0.00 G=0.00	CG	Double Symmetrical

		Average Luminance [cd/m ²]									
		45°	50°	55°	60°	65°	70°	75°	80°	85°	
0.0°		33993	24925	12266	469	529	622	780	1050	1868	---
90.0°		1059	1145	1272	1407	1497	1425	1188	1006	1558	---

Flush mounted or longitudinal view												
		Illumination(lx)										
A	A	2000	1000	750	500		<300					1.15
B	1		2000	1500	1000	750	500	<300				1.5
C					2000		1000	500	<300			1.85
D	2						2000	1000	500	<300		2.2
E	3							2000	1000	500	<300	2.55

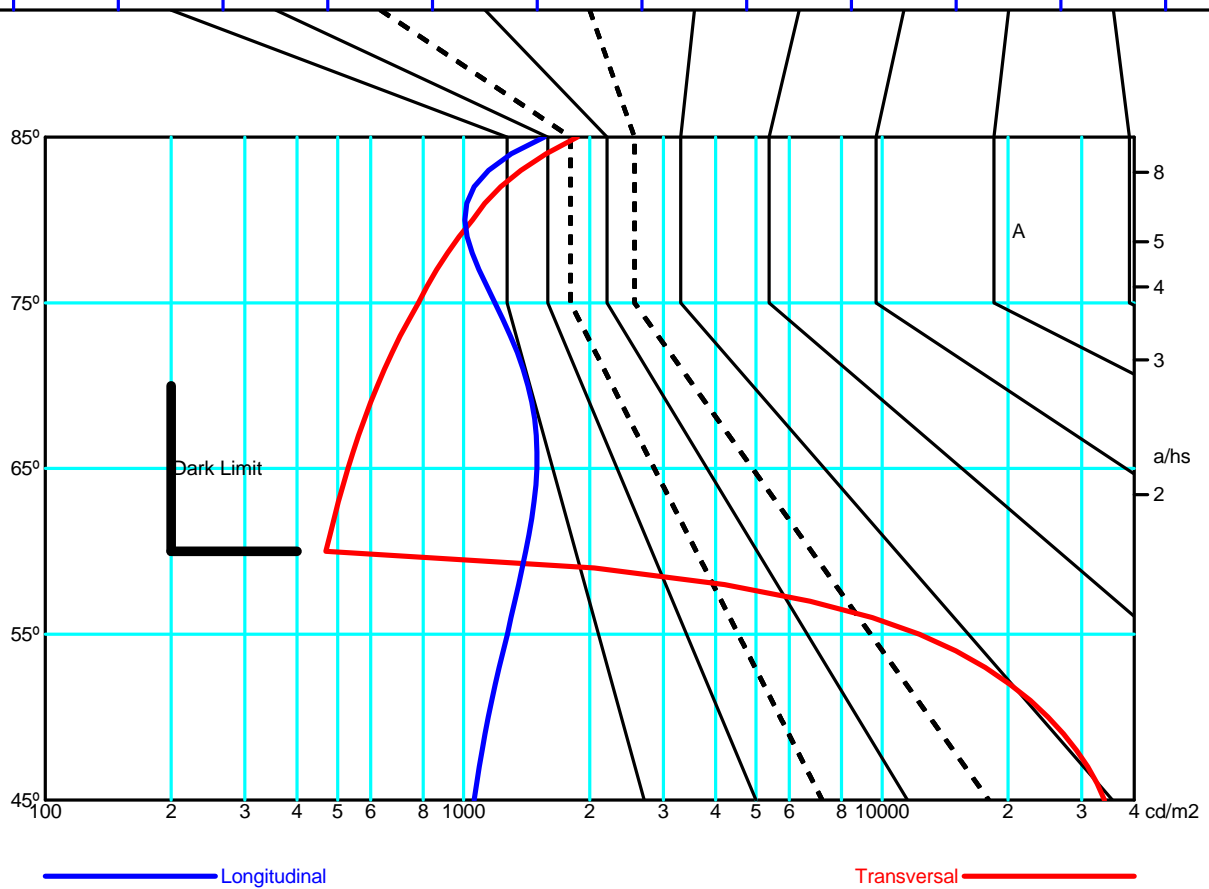

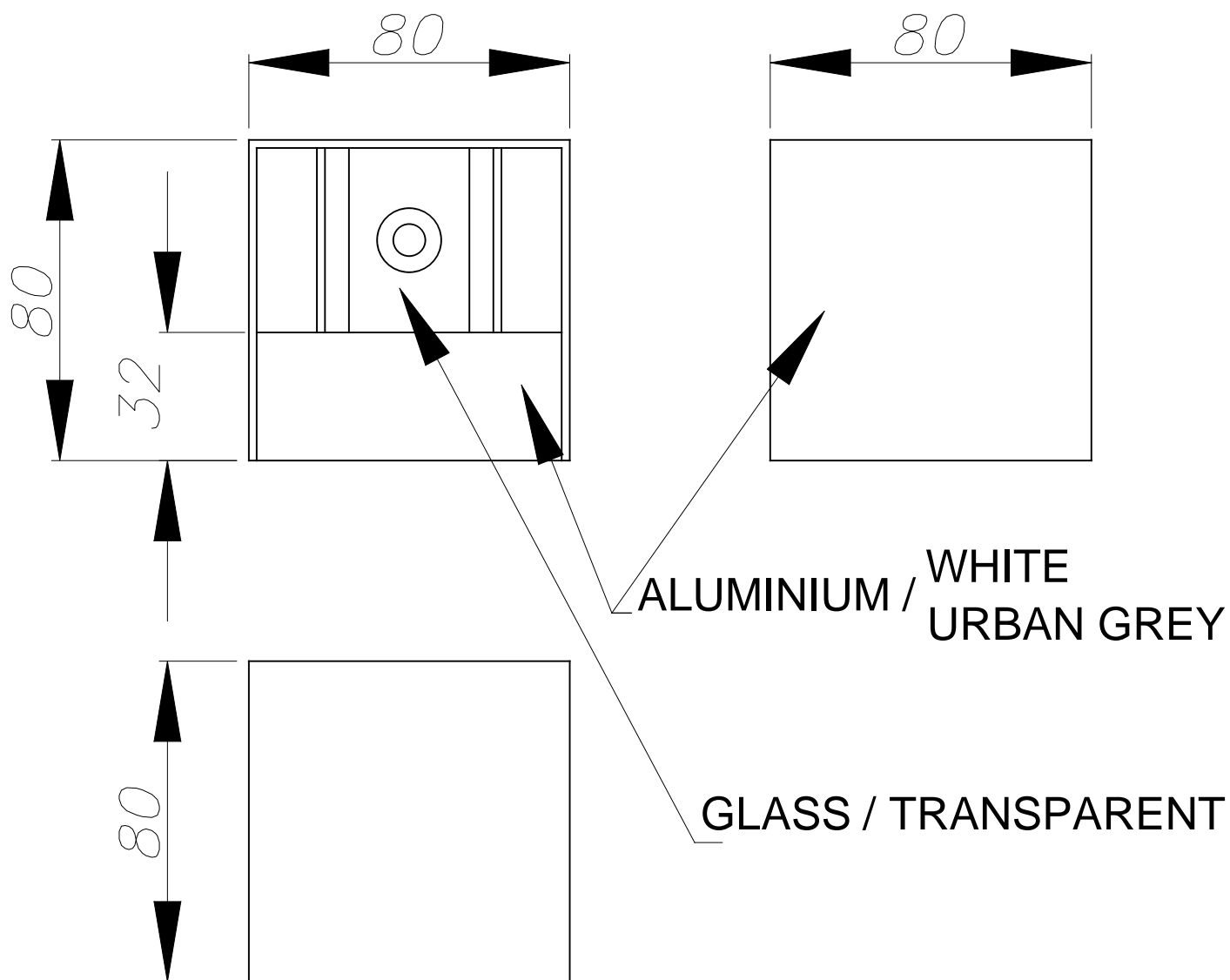

*PLANTILLA DE INSTALACIÓN
INSTALLATION TEMPLATE*

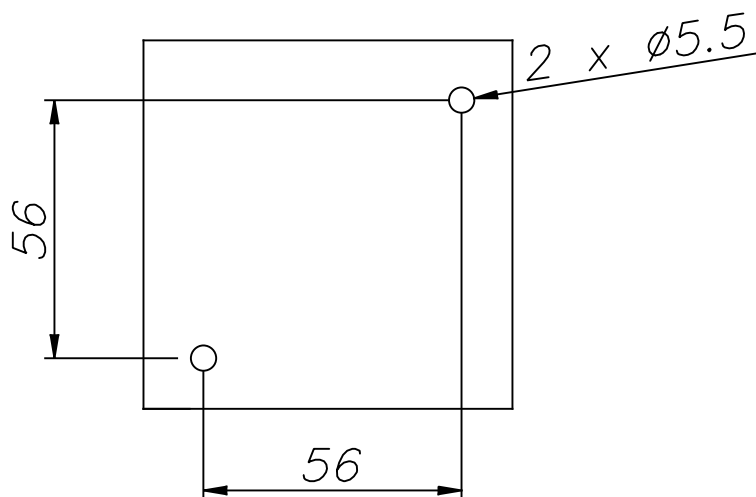

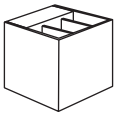

Rex

PX-0432 PX-0526

FOR LIGHT

