

**PX-0098-INO**

Surface-mounted wall light IP55 Koral E27 15W Stainless steel

**TECHNICAL FEATURES**



IP55 IK09

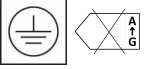

Luminaire total power : 15W

Voltage / frequency : 100-240V ~ 50/60Hz

Structure material : Stainless steel AISI202

Warranty : 2 Years

Structure finish : Stainless steel

Easily recyclable luminaire

Diffuser material : Polycarbonate

Diffuser finish : Opal

Max. size of light bulb : 167/55 mm

Recommended light bulb : E27

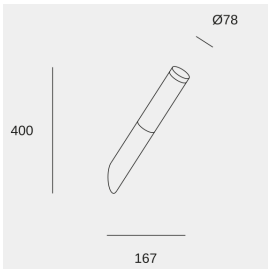

**LUMINOTECHNIC FEATURES**

Lampholder	Quantity	Light source power (W)	Correlated Colour Temperature (CCT)
E27	1	Max. power 15W	-

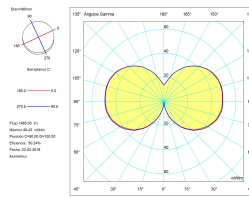

**LOGISTICS**

Net weight (kg): 0.45

Packaged weight (kg): 0.58

Packaging: 85mm x 85mm x 410mm

 12 Un

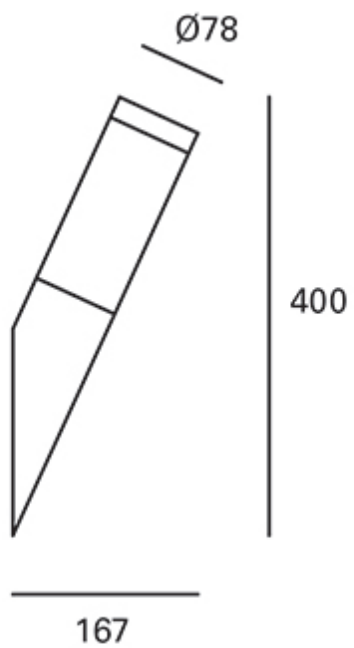

**Luminaire**

Code PX-0098-INO  
Name Baliza KORAL 23W CFL E27

**Measur.**

Code CL116A17F098G  
Name Baliza KORAL 23W CFL E27

Luminaire Flux	839.96 lm	Luminaire Power	23.00 W	Efficacy	36.52 lm/W	Efficiency	59.03%
Lamps Flux	1423.00 lm	Maximum value	59.91 cd/klm	Position	C=45.00 G=100.00	CG	Asymmetrical
Round Luminaire Round Luminous Area		Diam. Diam.	80 mm 80 mm	Height Height	400 mm 160 mm		
Horizontal Luminous Area Emitting area on Plane 0° Emitting area on Plane 90°		0.005027 m2 0.012800 m2 0.012800 m2		Emitting area on Plane 180° Emitting area on Plane 270° Glare area at 76°		0.012800 m2 0.012800 m2 0.013636 m2	
Coordinate system Date Measurement Distance		CG 21-03-2017 0.00		Symmetry Type Maximum Gamma Angle Measurement Flux		Asymmetrical 180 1423.00 lm	
Operator Temperature Humidity Notes		Asselum T2 25.00 °C 60.00 %		Source Voltage [V] Source current [A] Photocell			

Line		Code	Luminaire Lamps	Flux [lm]	Pow. [W]	Q.ty
		PHILIPS PL-E 23W	PHILIPS PL-E 23W	1423.00	23.00	1
C.I.E.	13 37 68 47 59		D DIN 5040	C12		
F UTE	--		B NBN	BZ 10		

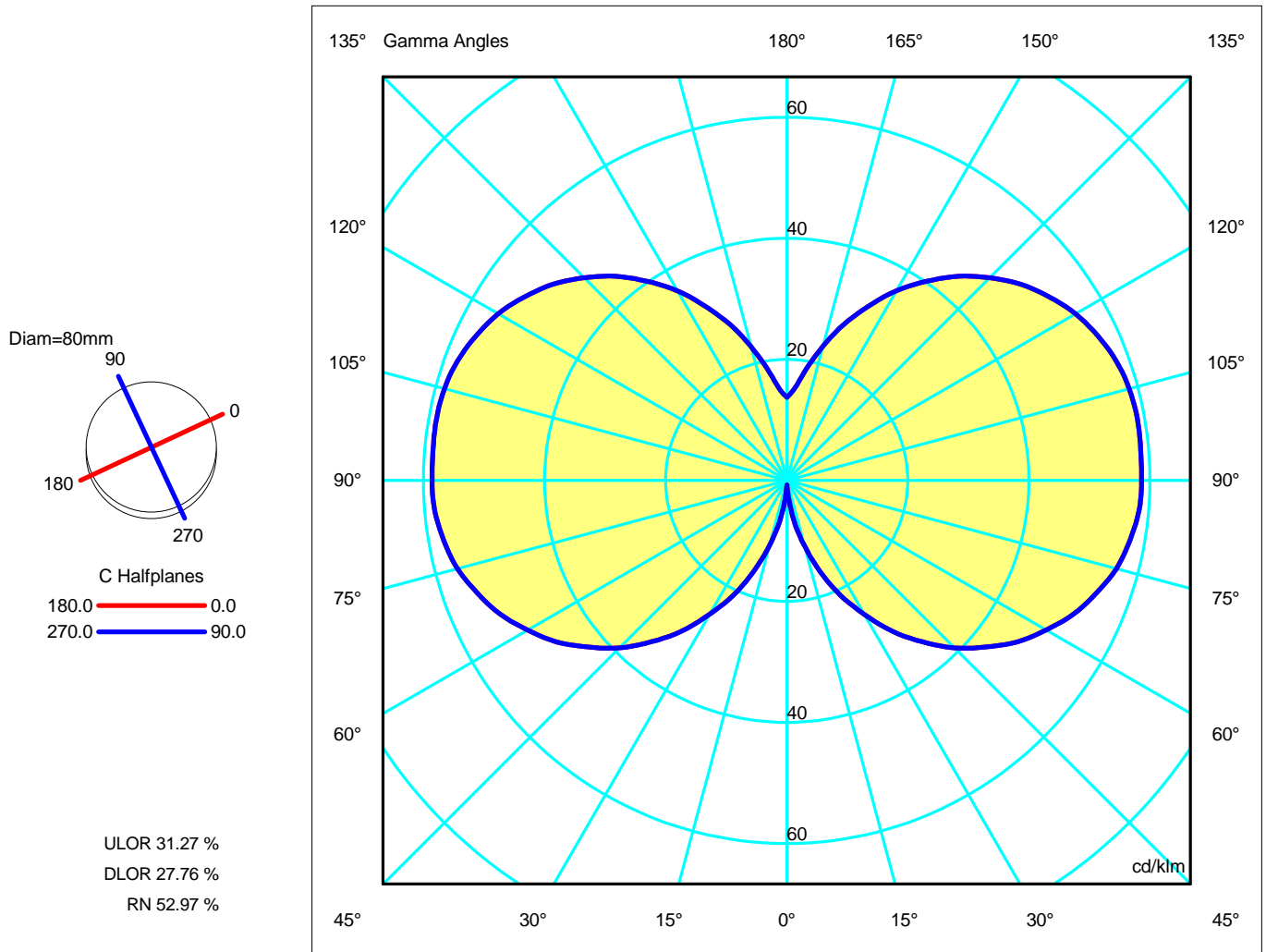



**Luminaire**  
 Code PX-0098-INO  
 Name Baliza KORAL 23W CFL E27  
**Measur.**  
 Code CL116A17F098G  
 Name Baliza KORAL 23W CFL E27

Luminaire Flux	839.96 lm	Luminaire Power	23.00 W	Efficacy	36.52 lm/W	Efficiency	59.03%
Lamps Flux	1423.00 lm	Maximum value	59.91 cd/klm	Position	C=45.00 G=100.00	CG	Asymmetrical

**Luminous Intensity Table cd/klm Table 1/1**

	C 0.00	C 15.00	C 30.00	C 45.00	C 60.00	C 75.00	C 90.00	C 105.00	C 120.00	C 135.00	C 150.00	C 165.00
G 0.0	0.75	0.75	0.75	0.75	0.75	0.75	0.75	0.75	0.75	0.75	0.75	0.75
G 5.0	2.58	1.46	2.22	1.31	2.22	1.46	2.58	1.46	2.22	1.31	2.22	1.46
G 10.0	6.76	6.58	6.47	6.64	6.47	6.58	6.76	6.58	6.47	6.64	6.47	6.58
G 15.0	11.13	11.06	10.96	11.25	10.96	11.06	11.13	11.06	10.96	11.25	10.96	11.06
G 20.0	15.95	15.86	15.69	16.19	15.69	15.86	15.95	15.86	15.69	16.19	15.69	15.86
G 25.0	20.90	20.74	20.57	21.17	20.57	20.74	20.90	20.74	20.57	21.17	20.57	20.74
G 30.0	25.49	25.51	25.32	26.14	25.32	25.51	25.49	25.51	25.32	26.14	25.32	25.51
G 35.0	30.42	30.27	29.97	30.90	29.97	30.27	30.42	30.27	29.97	30.90	29.97	30.27
G 40.0	34.77	34.53	34.37	35.29	34.37	34.53	34.77	34.53	34.37	35.29	34.37	34.53
G 45.0	39.12	38.83	38.49	39.70	38.49	38.83	39.12	38.83	38.49	39.70	38.49	38.83
G 50.0	42.81	42.47	42.34	43.56	42.34	42.47	42.81	42.47	42.34	43.56	42.34	42.47
G 55.0	46.47	46.07	45.73	47.23	45.73	46.07	46.47	46.07	45.73	47.23	45.73	46.07
G 60.0	49.41	49.04	48.80	50.33	48.80	49.04	49.41	49.04	48.80	50.33	48.80	49.04
G 65.0	52.25	51.81	51.46	53.13	51.46	51.81	52.25	51.81	51.46	53.13	51.46	51.81
G 70.0	54.40	53.96	53.69	55.38	53.69	53.96	54.40	53.96	53.69	55.38	53.69	53.96
G 75.0	56.33	55.76	55.42	57.25	55.42	55.76	56.33	55.76	55.42	57.25	55.42	55.76
G 80.0	57.50	56.95	56.66	58.57	56.66	56.95	57.50	56.95	56.66	58.57	56.66	56.95
G 85.0	58.36	57.78	57.44	59.36	57.44	57.78	58.36	57.78	57.44	59.36	57.44	57.78
G 90.0	58.61	58.03	57.68	59.66	57.68	58.03	58.61	58.03	57.68	59.66	57.68	58.03
G 95.0	58.66	58.14	57.80	59.83	57.80	58.14	58.66	58.14	57.80	59.83	57.80	58.14
G100.0	58.77	58.21	57.85	59.91	57.85	58.21	58.77	58.21	57.85	59.91	57.85	58.21
G105.0	58.55	57.96	57.57	59.67	57.57	57.96	58.55	57.96	57.57	59.67	57.57	57.96
G110.0	57.86	57.29	56.94	59.03	56.94	57.29	57.86	57.29	56.94	59.03	56.94	57.29
G115.0	56.63	56.12	55.82	57.84	55.82	56.12	56.63	56.12	55.82	57.84	55.82	56.12
G120.0	55.07	54.55	54.21	56.09	54.21	54.55	55.07	54.55	54.21	56.09	54.21	54.55
G125.0	52.91	52.32	52.11	54.00	52.11	52.32	52.91	52.32	52.11	54.00	52.11	52.32
G130.0	50.43	49.85	49.61	51.39	49.61	49.85	50.43	49.85	49.61	51.39	49.61	49.85
G135.0	47.38	46.77	46.71	48.26	46.71	46.77	47.38	46.77	46.71	48.26	46.71	46.77
G140.0	44.04	43.54	43.30	44.84	43.30	43.54	44.04	43.54	43.30	44.84	43.30	43.54
G145.0	40.17	39.63	39.67	40.88	39.67	39.63	40.17	39.63	39.67	40.88	39.67	39.63
G150.0	36.22	35.82	35.60	36.77	35.60	35.82	36.22	35.82	35.60	36.77	35.60	35.82
G155.0	31.72	31.36	31.34	32.19	31.34	31.36	31.72	31.36	31.34	32.19	31.34	31.36
G160.0	27.44	27.05	26.94	27.80	26.94	27.05	27.44	27.05	26.94	27.80	26.94	27.05
G165.0	22.92	22.60	22.59	23.24	22.59	22.60	22.92	22.60	22.59	23.24	22.59	22.60
G170.0	18.78	18.54	18.48	19.07	18.48	18.54	18.78	18.54	18.48	19.07	18.48	18.54
G175.0	15.36	15.18	15.13	15.58	15.13	15.18	15.36	15.18	15.13	15.58	15.13	15.18
G180.0	13.77	13.77	13.77	13.77	13.77	13.77	13.77	13.77	13.77	13.77	13.77	13.77

	C 180.00	C 195.00	C 210.00	C 225.00	C 240.00	C 255.00	C 270.00	C 285.00	C 300.00	C 315.00	C 330.00	C 345.00
G 0.0	0.75	0.75	0.75	0.75	0.75	0.75	0.75	0.75	0.75	0.75	0.75	0.75
G 5.0	2.58	1.46	2.22	1.31	2.22	1.46	2.58	1.46	2.22	1.31	2.22	1.46
G 10.0	6.76	6.58	6.47	6.64	6.47	6.58	6.76	6.58	6.47	6.64	6.47	6.58
G 15.0	11.13	11.06	10.96	11.25	10.96	11.06	11.13	11.06	10.96	11.25	10.96	11.06
G 20.0	15.95	15.86	15.69	16.19	15.69	15.86	15.95	15.86	15.69	16.19	15.69	15.86
G 25.0	20.90	20.74	20.57	21.17	20.57	20.74	20.90	20.74	20.57	21.17	20.57	20.74
G 30.0	25.49	25.51	25.32	26.14	25.32	25.51	25.49	25.51	25.32	26.14	25.32	25.51
G 35.0	30.42	30.27	29.97	30.90	29.97	30.27	30.42	30.27	29.97	30.90	29.97	30.27
G 40.0	34.77	34.53	34.37	35.29	34.37	34.53	34.77	34.53	34.37	35.29	34.37	34.53
G 45.0	39.12	38.83	38.49	39.70	38.49	38.83	39.12	38.83	38.49	39.70	38.49	38.83
G 50.0	42.81	42.47	42.34	43.56	42.34	42.47	42.81	42.47	42.34	43.56	42.34	42.47
G 55.0	46.47	46.07	45.73	47.23	45.73	46.07	46.47	46.07	45.73	47.23	45.73	46.07
G 60.0	49.41	49.04	48.80	50.33	48.80	49.04	49.41	49.04	48.80	50.33	48.80	49.04
G 65.0	52.25	51.81	51.46	53.13	51.46	51.81	52.25	51.81	51.46	53.13	51.46	51.81
G 70.0	54.40	53.96	53.69	55.38	53.69	53.96	54.40	53.96	53.69	55.38	53.69	53.96
G 75.0	56.33	55.76	55.42	57.25	55.42	55.76	56.33	55.76	55.42	57.25	55.42	55.76
G 80.0	57.50	56.95	56.66	58.57	56.66	56.95	57.50	56.95	56.66	58.57	56.66	56.95
G 85.0	58.36	57.78	57.44	59.36	57.44	57.78	58.36	57.78	57.44	59.36	57.44	57.78
G 90.0	58.61	58.03	57.68	59.66	57.68	58.03	58.61	58.03	57.68	59.66	57.68	58.03
G 95.0	58.66	58.14	57.80	59.83	57.80	58.14	58.66	58.14	57.80	59.83	57.80	58.14
G100.0	58.77	58.21	57.85	59.91	57.85	58.21	58.77	58.21	57.85	59.91	57.85	58.21
G105.0	58.55	57.96	57.57	59.67	57.57	57.96	58.55	57.96	57.57	59.67	57.57	57.96
G110.0	57.86	57.29	56.94	59.03	56.94	57.29	57.86	57.29	56.94	59.03	56.94	57.29
G115.0	56.63	56.12	55.82	57.84	55.82	56.12	56.63	56.12	55.82	57.84	55.82	56.12
G120.0	55.07	54.55	54.21	56.09	54.21	54.55	55.07	54.55	54.21	56.09	54.21	54.55
G125.0	52.91	52.32	52.11	54.00	52.11	52.32	52.91	52.32	52.11	54.00	52.11	52.32
G130.0	50.43	49.85	49.61	51.39	49.61	49.85	50.43	49.85	49.61	51.39	49.61	49.85
G135.0	47.38	46.77	46.71	48.26	46.71	46.77	47.38	46.77	46.71	48.26	46.71	46.77
G140.0	44.04	43.54	43.30	44.84	43.30	43.54	44.04	43.54	43.30	44.84	43.30	43.54
G145.0	40.17	39.63	39.67	40.88	39.67	39.63	40.17	39.63	39.67	40.88	39.67	39.63
G150.0	36.22	35.82	35.60	36.77	35.60	35.82	36.22	35.82	35.60	36.77	35.60	35.82
G155.0	31.72	31.36	31.34	32.19	31.34	31.36	31.72	31.36	31.34	32.19	31.34	31.36
G160.0	27.44	27.05	26.94	27.80	26.94	27.05	27.44	27.05	26.94	27.80	26.94	27.05
G165.0	22.92	22.60	22.59	23.24	22.59	22.60	22.92	22.60	22.59	23.24	22.59	22.60
G170.0	18.78	18.54	18.48	19.07	18.48	18.54	18.78	18.54	18.48	19.07	18.48	18.54
G175.0	15.36	15.18	15.13	15.58	15.13	15.18	15.36	15.18	15.13	15.58	15.13	15.18
G180.0	13.77	13.77	13.77	13.77	13.77	13.77	13.77	13.77	13.77	13.77	13.77	13.77

**Luminaire**

Code PX-0098-INO  
 Name Baliza KORAL 23W CFL E27

**Measur.**

Code CL116A17F098G  
 Name Baliza KORAL 23W CFL E27

Luminaire Flux	839.96 lm	Luminaire Power	23.00 W	Efficacy	36.52 lm/W	Efficiency	59.03%
Lamps Flux	1423.00 lm	Maximum value	59.91 cd/klm	Position	C=45.00 G=100.00	CG	Asymmetrical

Diam=80mm

C Halfplanes

180.0 ——— 0.0  
 270.0 ——— 90.0

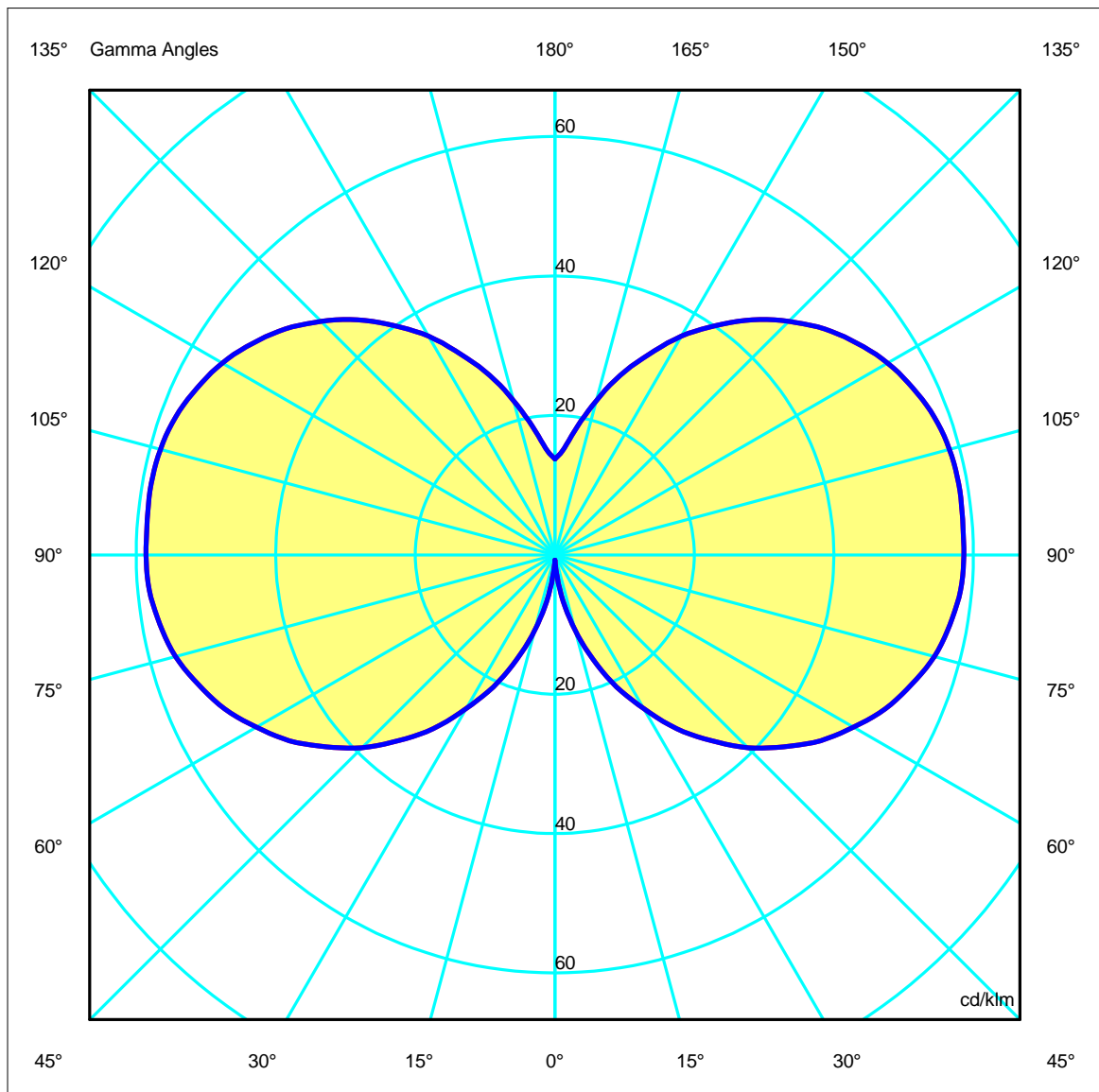
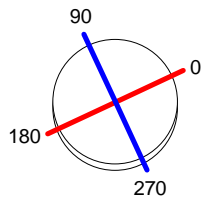



---

**Luminaire**Code PX-0098-INO  
Name Baliza KORAL 23W CFL E27**Measurem.**Code CL116A17F098G  
Name Baliza KORAL 23W CFL E27

---

Luminaire Flux	839.96 lm	Luminaire Power	23.00 W	Efficacy	36.52 lm/W	Efficiency	59.03%
Lamps Flux	1423.00 lm	Maximum value	59.91 cd/klm	Position	C=45.00 G=100.00	CG	Asymmetrical

---

Left beam angle not found, gamma = -80

Left beam angle not found, gamma = -80

Left beam angle not found, gamma = -80



**Luminaire**

Code PX-0098-INO  
Name Baliza KORAL 23W CFL E27

**Measurement**

Code CL116A17F098G  
Name Baliza KORAL 23W CFL E27

Luminaire Flux	839.96 lm	Luminaire Power	23.00 W	Efficacy	36.52 lm/W	Efficiency	59.03%
Lamps Flux	1423.00 lm	Maximum value	59.91 cd/klm	Position	C=45.00 G=100.00	CG	Asymmetrical

**UGR**  
S = 0.250

Reflectancies										
Ceiling/Cavity	0.7	0.7	0.5	0.5	0.3	0.7	0.7	0.5	0.5	0.3
Walls	0.5	0.3	0.5	0.3	0.3	0.5	0.3	0.5	0.3	0.3
WorkingPlane	0.2	0.2	0.2	0.2	0.2	0.2	0.2	0.2	0.2	0.2
RoomDimensions	ViewedCrosswise					ViewedEndwise				
x=2H y=2H	14.3	15.3	15.2	16.2	17.5	14.3	15.3	15.2	16.2	17.5
x=2H y=3H	17.3	18.2	18.2	19.1	20.4	17.3	18.2	18.2	19.1	20.4
x=2H y=4H	18.8	19.6	19.7	20.6	21.9	18.8	19.6	19.7	20.6	21.9
x=2H y=6H	20.3	21.1	21.2	22.0	23.3	20.3	21.1	21.2	22.0	23.3
x=2H y=8H	21.0	21.7	21.9	22.7	24.0	21.0	21.7	21.9	22.7	24.0
x=2H y=12H	21.7	22.4	22.7	23.4	24.7	21.7	22.4	22.7	23.4	24.7
x=4H y=2H	15.4	16.2	16.4	17.2	18.5	15.4	16.2	16.4	17.2	18.5
x=4H y=3H	18.4	19.2	19.4	20.2	21.5	18.4	19.2	19.4	20.2	21.5
x=4H y=4H	20.0	20.7	21.0	21.7	23.0	20.0	20.7	21.0	21.7	23.0
x=4H y=6H	21.6	22.2	22.6	23.3	24.6	21.6	22.2	22.6	23.3	24.6
x=4H y=8H	22.4	23.0	23.5	24.0	25.4	22.4	23.0	23.5	24.0	25.4
x=4H y=12H	23.2	23.7	24.2	24.8	26.1	23.2	23.7	24.2	24.8	26.1
x=8H y=4H	20.7	21.2	21.7	22.3	23.7	20.7	21.2	21.7	22.3	23.7
x=8H y=6H	22.5	23.0	23.5	24.0	25.4	22.5	23.0	23.5	24.0	25.4
x=8H y=8H	23.4	23.8	24.5	24.9	26.3	23.4	23.8	24.5	24.9	26.3
x=8H y=12H	24.4	24.7	25.4	25.8	27.2	24.4	24.7	25.4	25.8	27.2
x=12H y=4H	20.8	21.3	21.8	22.4	23.7	20.8	21.3	21.8	22.4	23.7
x=12H y=6H	22.7	23.1	23.8	24.2	25.6	22.7	23.1	23.8	24.2	25.6
x=12H y=8H	23.8	24.1	24.8	25.2	26.6	23.8	24.1	24.8	25.2	26.6

**Luminaire**

Code PX-0098-INO  
 Name Baliza KORAL 23W CFL E27

**Measur.**

Code CL116A17F098G  
 Name Baliza KORAL 23W CFL E27

Luminaire Flux	839.96 lm	Luminaire Power	23.00 W	Efficacy	36.52 lm/W	Efficiency	59.03%
Lamps Flux	1423.00 lm	Maximum value	59.91 cd/klm	Position	C=45.00 G=100.00	CG	Asymmetrical

Diam=80mm

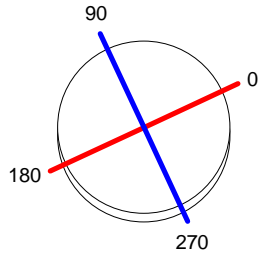

C Halfplanes

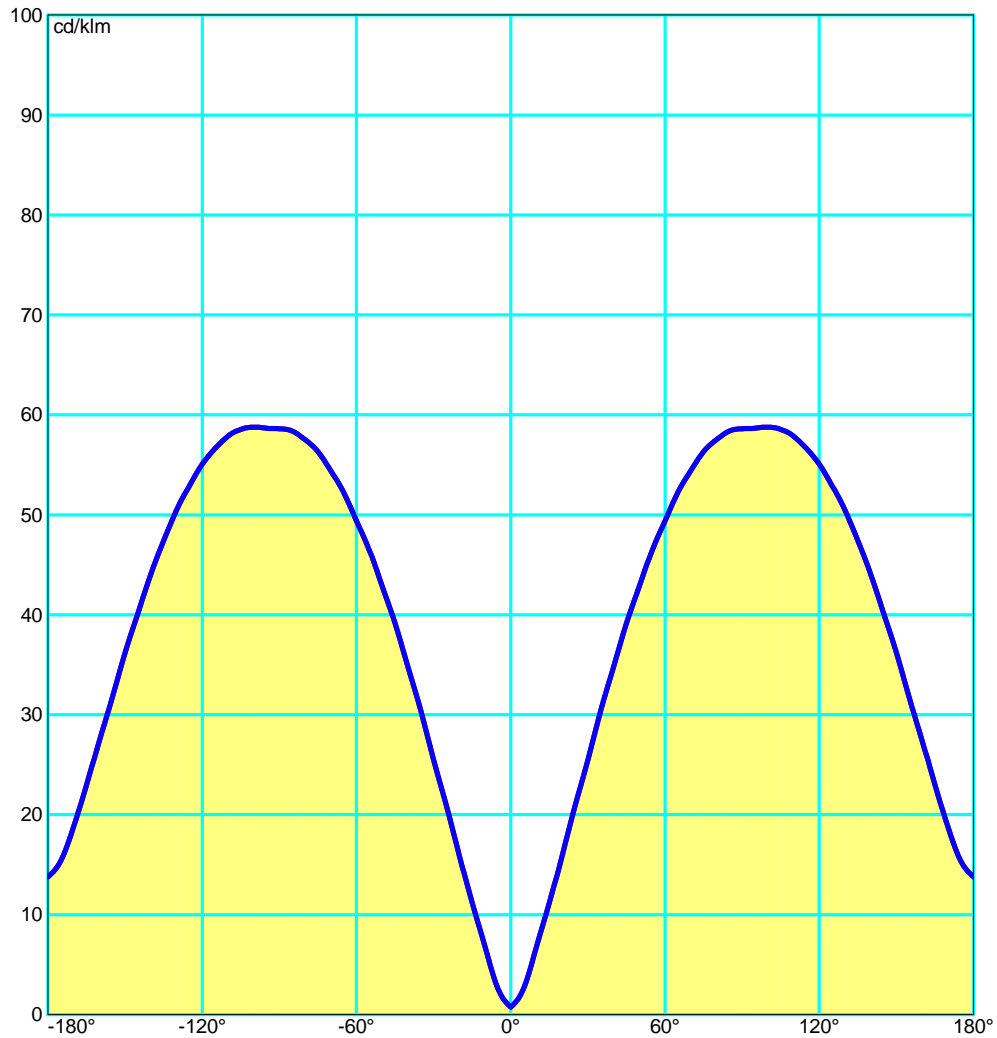

**Luminaire**  
 Code PX-0098-INO  
 Name Baliza KORAL 23W CFL E27  
**Measur.**  
 Code CL116A17F098G  
 Name Baliza KORAL 23W CFL E27

Luminaire Flux	839.96 lm	Luminaire Power	23.00 W	Efficacy	36.52 lm/W	Efficiency	59.03%
Lamps Flux	1423.00 lm	Maximum value	59.91 cd/klm	Position	C=45.00 G=100.00	CG	Asymmetrical

Luminance





**Luminaire**

Code PX-0098-INO  
Name Baliza KORAL 23W CFL E27

**Measurment**

Code CL116A17F098G  
Name Baliza KORAL 23W CFL E27

Luminaire Flux	839.96 lm	Luminaire Power	23.00 W	Efficacy	36.52 lm/W	Efficiency	59.03%
Lamps Flux	1423.00 lm	Maximum value	59.91 cd/klm	Position	C=45.00 G=100.00	CG	Asymmetrical

**Luminance cd/m2 Table 1/3**

	C 0.00	C 10.00	C 20.00	C 30.00	C 40.00	C 50.00	C 60.00	C 70.00	C 80.00	C 90.00	C 100.00	C 110.00	C 120.00
G 0.0	213.04	213.04	213.04	213.04	213.04	213.04	213.04	213.04	213.04	213.04	213.04	213.04	213.04
G 5.0	599.34	367.97	395.44	515.75	355.10	359.85	515.75	376.45	415.44	599.34	415.33	376.70	515.75
G 10.0	1340.80	1317.10	1292.31	1284.42	1310.37	1310.77	1284.42	1290.71	1321.10	1340.80	1321.09	1290.73	1284.42
G 15.0	1939.71	1934.00	1915.07	1908.73	1948.39	1948.45	1908.73	1914.85	1934.55	1939.71	1934.55	1914.85	1908.73
G 20.0	2493.26	2483.86	2462.12	2452.57	2515.18	2515.18	2452.57	2462.14	2489.21	2493.26	2489.21	2462.14	2452.57
G 25.0	2984.20	2973.46	2943.85	2937.10	3004.58	3004.70	2937.10	2943.36	2974.68	2984.20	2974.68	2943.37	2937.10
G 30.0	3373.31	3382.75	3367.03	3350.40	3436.93	3436.66	3350.40	3367.03	3374.66	3373.31	3374.66	3367.03	3350.40
G 35.0	3777.74	3765.04	3734.57	3721.65	3812.44	3812.42	3721.65	3734.66	3772.59	3777.74	3772.59	3734.66	3721.65
G 40.0	4096.92	4081.85	4050.03	4049.83	4135.22	4135.43	4049.83	4049.23	4083.87	4096.92	4083.86	4049.24	4049.83
G 45.0	4416.08	4401.63	4355.75	4345.09	4452.73	4452.87	4345.09	4355.17	4403.08	4416.08	4403.08	4355.18	4345.09
G 50.0	4673.29	4652.02	4615.90	4621.70	4727.89	4728.20	4621.70	4614.65	4655.15	4673.29	4655.14	4614.67	4621.70
G 55.0	4946.77	4925.43	4874.05	4867.73	4994.64	4994.90	4867.73	4872.99	4928.09	4946.77	4928.08	4873.00	4867.73
G 60.0	5170.71	5150.51	5105.29	5106.53	5234.10	5234.36	5106.53	5104.24	5153.13	5170.71	5153.12	5104.25	5106.53
G 65.0	5417.40	5394.25	5340.23	5335.52	5472.98	5473.27	5335.52	5339.05	5397.19	5417.40	5397.18	5339.07	5335.52
G 70.0	5630.84	5606.83	5556.24	5557.21	5696.40	5696.72	5557.21	5554.96	5610.05	5630.84	5610.04	5554.97	5557.21
G 75.0	5865.48	5833.31	5773.12	5771.18	5922.49	5922.94	5771.18	5771.30	5837.87	5865.48	5837.86	5771.32	5771.18
G 80.0	6070.81	6038.95	5979.32	5981.51	6142.52	6142.97	5981.51	5977.52	6043.46	6070.81	6043.45	5977.54	5981.51
G 85.0	6296.58	6262.55	6198.17	6196.94	6361.73	6362.21	6196.94	6196.24	6267.35	6296.58	6267.34	6196.27	6196.94
G 90.0	6515.37	6480.28	6413.17	6412.76	6587.50	6587.99	6412.76	6411.20	6485.21	6515.37	6485.19	6411.23	6412.76



**Luminaire**

Code PX-0098-INO  
Name Baliza KORAL 23W CFL E27

**Measur.**

Code CL116A17F098G  
Name Baliza KORAL 23W CFL E27

Luminaire Flux	839.96 lm	Luminaire Power	23.00 W	Efficacy	36.52 lm/W	Efficiency	59.03%
Lamps Flux	1423.00 lm	Maximum value	59.91 cd/klm	Position	C=45.00 G=100.00	CG	Asymmetrical

**Luminance cd/m2 Table 2/3**

	C 130.00	C 140.00	C 150.00	C 160.00	C 170.00	C 180.00	C 190.00	C 200.00	C 210.00	C 220.00	C 230.00	C 240.00	C 250.00
G 0.0	213.04	213.04	213.04	213.04	213.04	213.04	213.04	213.04	213.04	213.04	213.04	213.04	213.04
G 5.0	358.50	358.50	515.75	376.70	415.34	599.34	415.34	376.70	515.75	358.50	358.50	515.75	376.70
G 10.0	1310.66	1310.66	1284.42	1290.73	1321.09	1340.80	1321.09	1290.73	1284.42	1310.66	1310.66	1284.42	1290.73
G 15.0	1948.43	1948.43	1908.73	1914.85	1934.55	1939.71	1934.55	1914.85	1908.73	1948.43	1948.43	1908.73	1914.85
G 20.0	2515.18	2515.18	2452.57	2462.14	2489.21	2493.26	2489.21	2462.14	2452.57	2515.18	2515.18	2452.57	2462.14
G 25.0	3004.66	3004.66	2937.10	2943.37	2974.68	2984.20	2974.68	2943.37	2937.10	3004.66	3004.66	2937.10	2943.37
G 30.0	3436.74	3436.74	3350.40	3367.03	3374.66	3373.31	3374.66	3367.03	3350.40	3436.74	3436.74	3350.40	3367.03
G 35.0	3812.42	3812.42	3721.65	3734.66	3772.59	3777.74	3772.59	3734.66	3721.65	3812.42	3812.42	3721.65	3734.66
G 40.0	4135.37	4135.37	4049.83	4049.24	4083.86	4096.92	4083.86	4049.24	4049.83	4135.37	4135.37	4049.83	4049.24
G 45.0	4452.83	4452.83	4345.09	4355.18	4403.08	4416.08	4403.08	4355.18	4345.09	4452.83	4452.83	4345.09	4355.18
G 50.0	4728.12	4728.12	4621.70	4614.67	4655.14	4673.29	4655.14	4614.67	4621.70	4728.12	4728.12	4621.70	4614.67
G 55.0	4994.83	4994.83	4867.73	4873.00	4928.08	4946.77	4928.08	4873.00	4867.73	4994.83	4994.83	4867.73	4873.00
G 60.0	5234.29	5234.29	5106.53	5104.25	5153.12	5170.71	5153.12	5104.25	5106.53	5234.29	5234.29	5106.53	5104.25
G 65.0	5473.19	5473.19	5335.52	5339.06	5397.18	5417.40	5397.18	5339.06	5335.52	5473.19	5473.19	5335.52	5339.06
G 70.0	5696.63	5696.63	5557.21	5554.97	5610.04	5630.84	5610.04	5554.97	5557.21	5696.63	5696.63	5557.21	5554.97
G 75.0	5922.81	5922.81	5771.18	5771.32	5837.86	5865.48	5837.86	5771.32	5771.18	5922.81	5922.81	5771.18	5771.32
G 80.0	6142.84	6142.84	5981.51	5977.54	6043.45	6070.81	6043.45	5977.54	5981.51	6142.84	6142.84	5981.51	5977.54
G 85.0	6362.07	6362.07	6196.94	6196.27	6267.34	6296.58	6267.34	6196.27	6196.94	6362.07	6362.07	6196.94	6196.27
G 90.0	6587.85	6587.85	6412.76	6411.22	6485.20	6515.37	6485.20	6411.22	6412.76	6587.85	6587.85	6412.76	6411.22



**Luminaire**

Code PX-0098-INO  
Name Baliza KORAL 23W CFL E27

**Measur.**

Code CL116A17F098G  
Name Baliza KORAL 23W CFL E27

Luminaire Flux	839.96 lm	Luminaire Power	23.00 W	Efficacy	36.52 lm/W	Efficiency	59.03%
Lamps Flux	1423.00 lm	Maximum value	59.91 cd/klm	Position	C=45.00 G=100.00	CG	Asymmetrical

**Luminance cd/m2 Table 3/3**

	C 260.00	C 270.00	C 280.00	C 290.00	C 300.00	C 310.00	C 320.00	C 330.00	C 340.00	C 350.00
G 0.0	213.04	213.04	213.04	213.04	213.04	213.04	213.04	213.04	213.04	213.04
G 5.0	415.33	599.34	415.44	376.45	515.75	359.85	355.10	515.75	395.44	367.97
G 10.0	1321.09	1340.80	1321.10	1290.71	1284.42	1310.77	1310.37	1284.42	1292.31	1317.10
G 15.0	1934.55	1939.71	1934.55	1914.85	1908.73	1948.45	1948.39	1908.73	1915.07	1934.00
G 20.0	2489.21	2493.26	2489.21	2462.14	2452.57	2515.18	2515.18	2452.57	2462.12	2483.86
G 25.0	2974.68	2984.20	2974.68	2943.36	2937.10	3004.70	3004.58	2937.10	2943.85	2973.46
G 30.0	3374.66	3373.31	3374.66	3367.03	3350.40	3436.66	3436.93	3350.40	3367.03	3382.75
G 35.0	3772.59	3777.74	3772.59	3734.66	3721.65	3812.42	3812.44	3721.65	3734.57	3765.04
G 40.0	4083.86	4096.92	4083.87	4049.23	4049.83	4135.43	4135.22	4049.83	4050.03	4081.85
G 45.0	4403.08	4416.08	4403.08	4355.17	4345.09	4452.87	4452.73	4345.09	4355.75	4401.63
G 50.0	4655.14	4673.29	4655.15	4614.65	4621.70	4728.20	4727.89	4621.70	4615.90	4652.02
G 55.0	4928.08	4946.77	4928.09	4872.99	4867.73	4994.90	4994.64	4867.73	4874.05	4925.43
G 60.0	5153.12	5170.71	5153.13	5104.24	5106.53	5234.36	5234.10	5106.53	5105.29	5150.51
G 65.0	5397.18	5417.40	5397.19	5339.05	5335.52	5473.27	5472.98	5335.52	5340.23	5394.25
G 70.0	5610.04	5630.84	5610.05	5554.96	5557.21	5696.72	5696.40	5557.21	5556.24	5606.83
G 75.0	5837.86	5865.48	5837.87	5771.30	5771.18	5922.94	5922.49	5771.18	5773.12	5833.31
G 80.0	6043.45	6070.81	6043.46	5977.52	5981.51	6142.97	6142.52	5981.51	5979.32	6038.95
G 85.0	6267.34	6296.58	6267.35	6196.24	6196.94	6362.21	6361.73	6196.94	6198.17	6262.55
G 90.0	6485.19	6515.37	6485.21	6411.20	6412.76	6587.99	6587.50	6412.76	6413.17	6480.28

**Luminaire**  
 Code PX-0098-INO  
 Name Baliza KORAL 23W CFL E27  
**Measur.**  
 Code CL116A17F098G  
 Name Baliza KORAL 23W CFL E27

Luminaire Flux	839.96 lm	Luminaire Power	23.00 W	Efficacy	36.52 lm/W	Efficiency	59.03%
Lamps Flux	1423.00 lm	Maximum value	59.91 cd/klm	Position	C=45.00 G=100.00	CG	Asymmetrical

**PERCENTAGE ISOCANDLES**

Projection: Equal Area Tilting Angle:0°

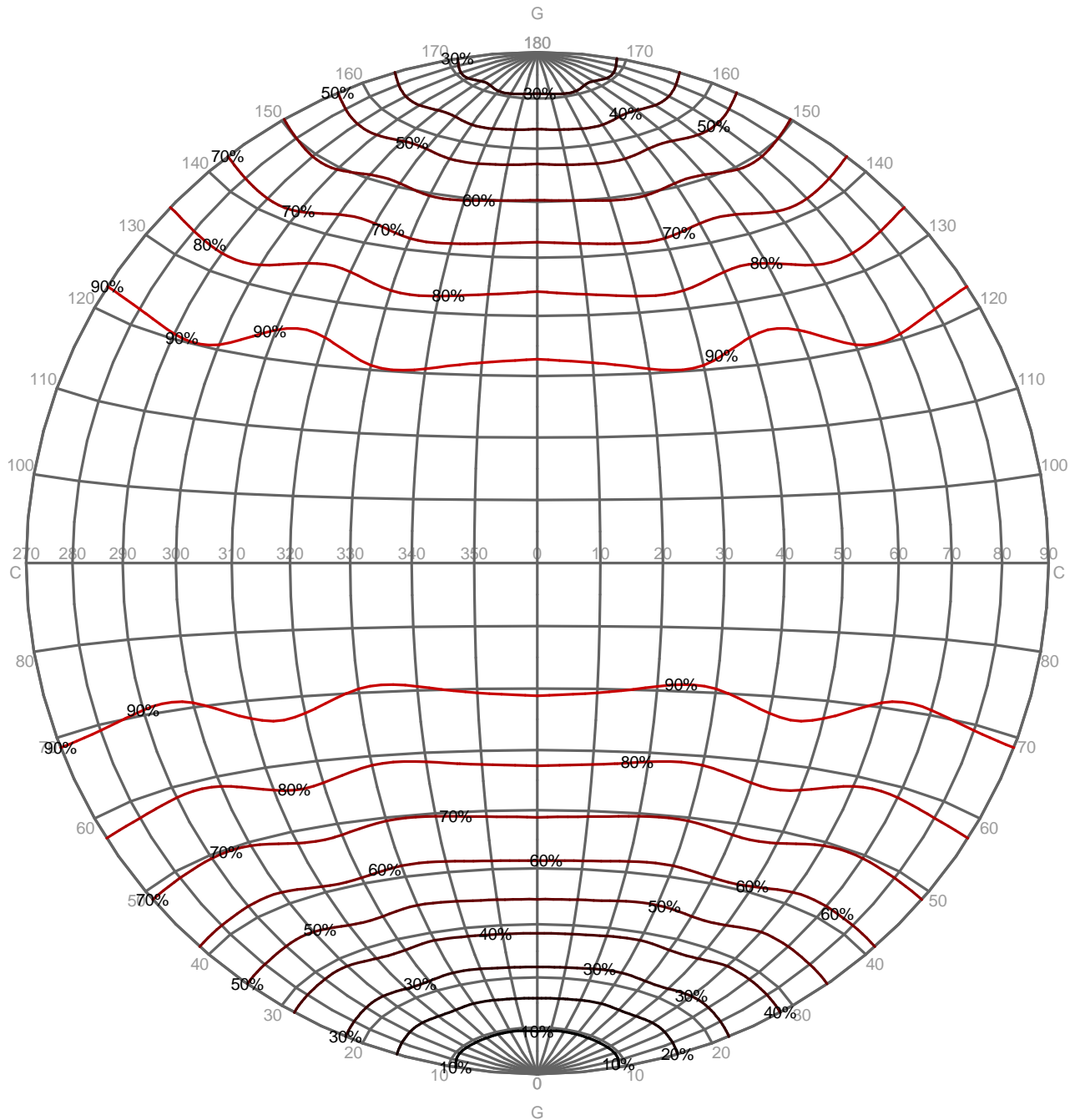

**Luminaire**

Code PX-0098-INO  
 Name Baliza KORAL 23W CFL E27

**Measur.**

Code CL116A17F098G  
 Name Baliza KORAL 23W CFL E27

Luminaire Flux	839.96 lm	Luminaire Power	23.00 W	Efficacy	36.52 lm/W	Efficiency	59.03%
Lamps Flux	1423.00 lm	Maximum value	59.91 cd/klm	Position	C=45.00 G=100.00	CG	Asymmetrical

Isolux (Floor)

Luminaire position X=0.00m Y=0.00m Z=2.50m

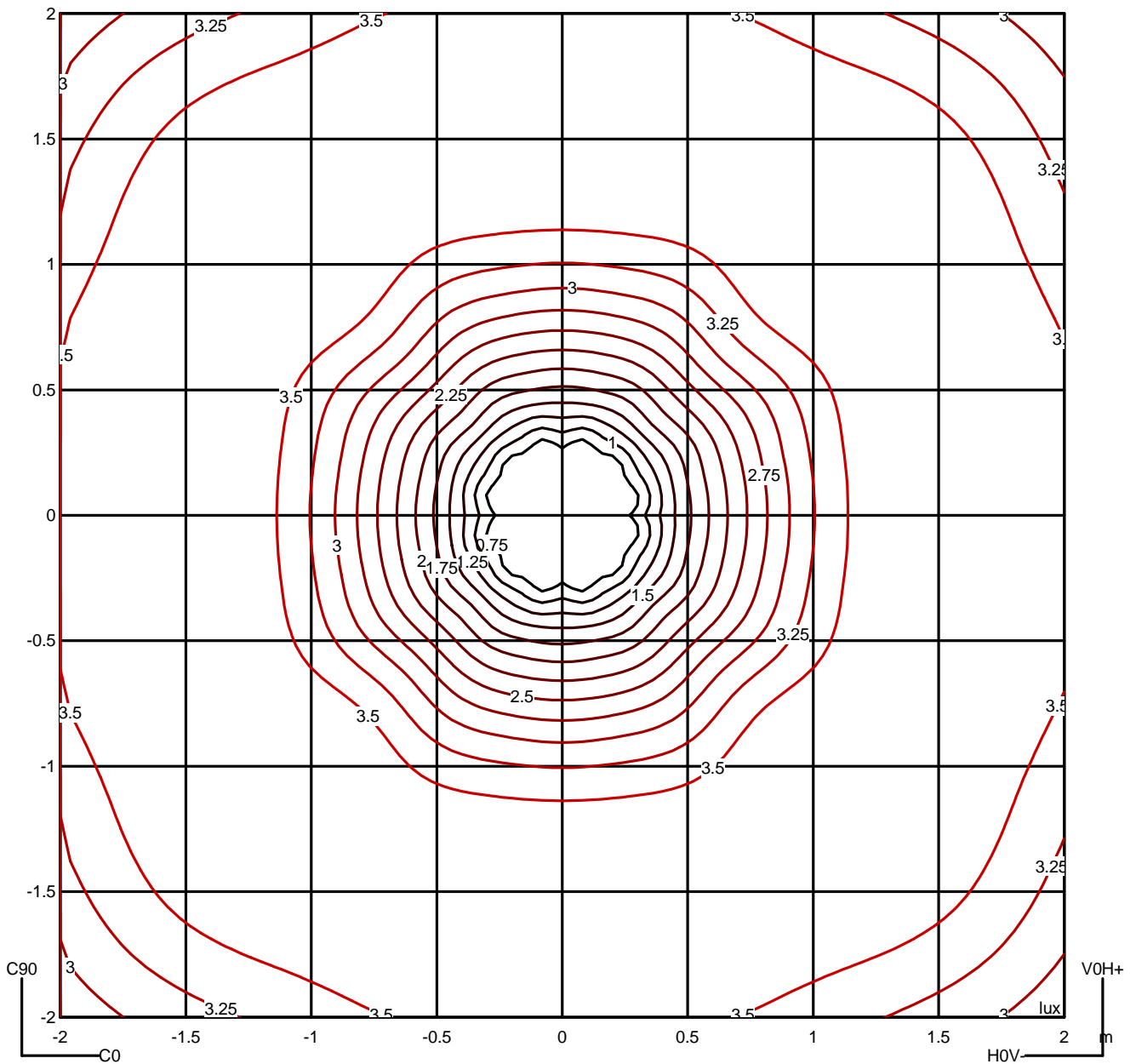

**Luminaire**

Code PX-0098-INO  
Name Baliza KORAL 23W CFL E27

**Measurement**

Code CL116A17F098G  
Name Baliza KORAL 23W CFL E27

Luminaire Flux	839.96 lm	Luminaire Power	23.00 W	Efficacy	36.52 lm/W	Efficiency	59.03%
Lamps Flux	1423.00 lm	Maximum value	59.91 cd/klm	Position	C=45.00 G=100.00	CG	Asymmetrical

Average Luminance [cd/m <sup>2</sup> ]										
0.0°	45°	50°	55°	60°	65°	70°	75°	80°	85°	---
	4416	4673	4947	5171	5417	5631	5865	6071	6297	

Flush mounted or transversal view												
		Illumination (lx)										
A	A	2000	1000	750	500		<300					1.15
B	1		2000	1500	1000	750	500	<300				1.5
C					2000		1000	500	<300			1.85
D	2						2000	1000	500	<300		2.2
E	3							2000	1000	500	<300	2.55

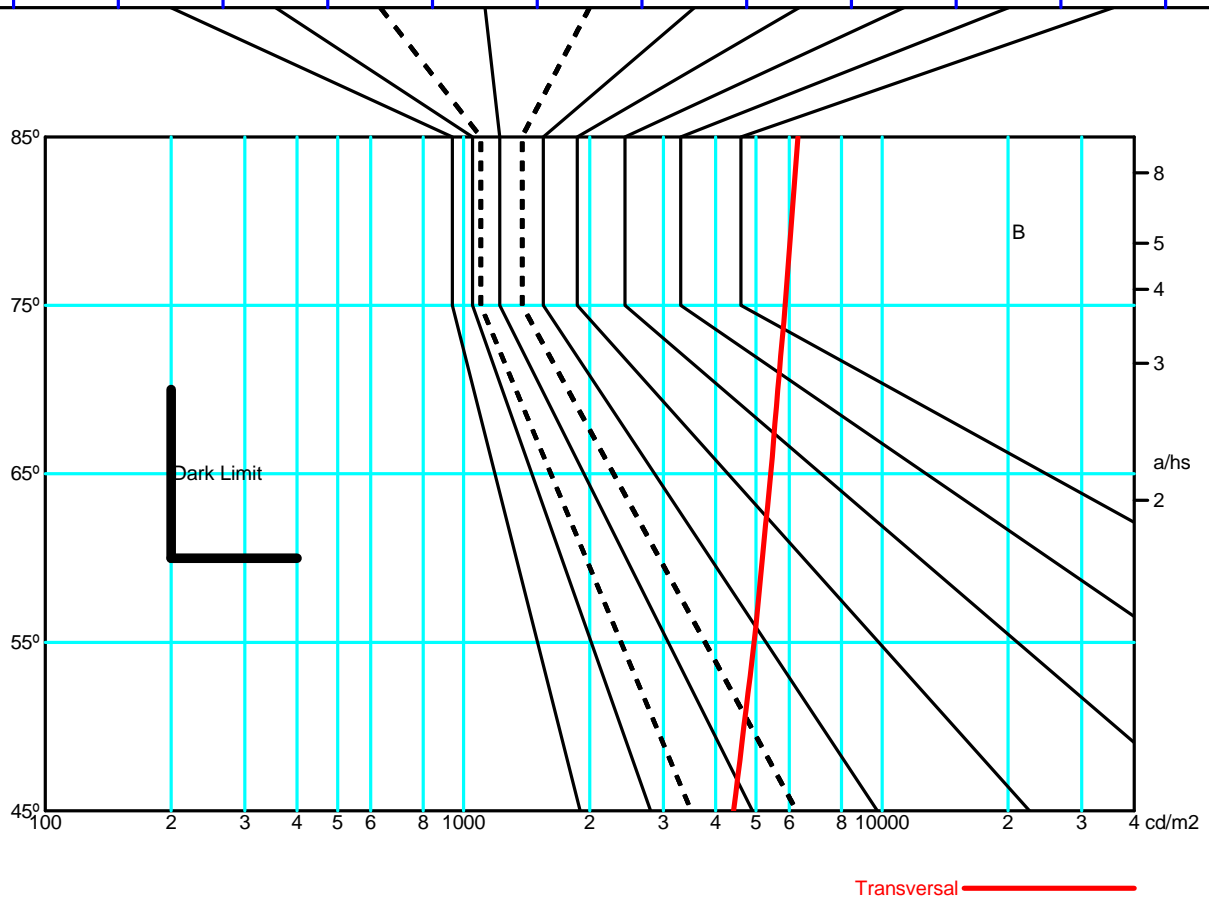

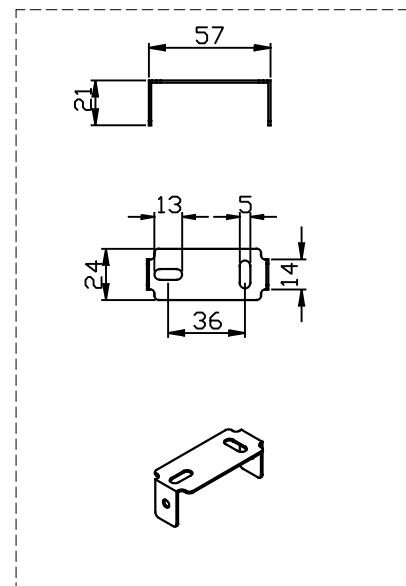
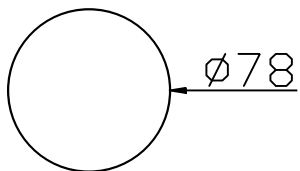
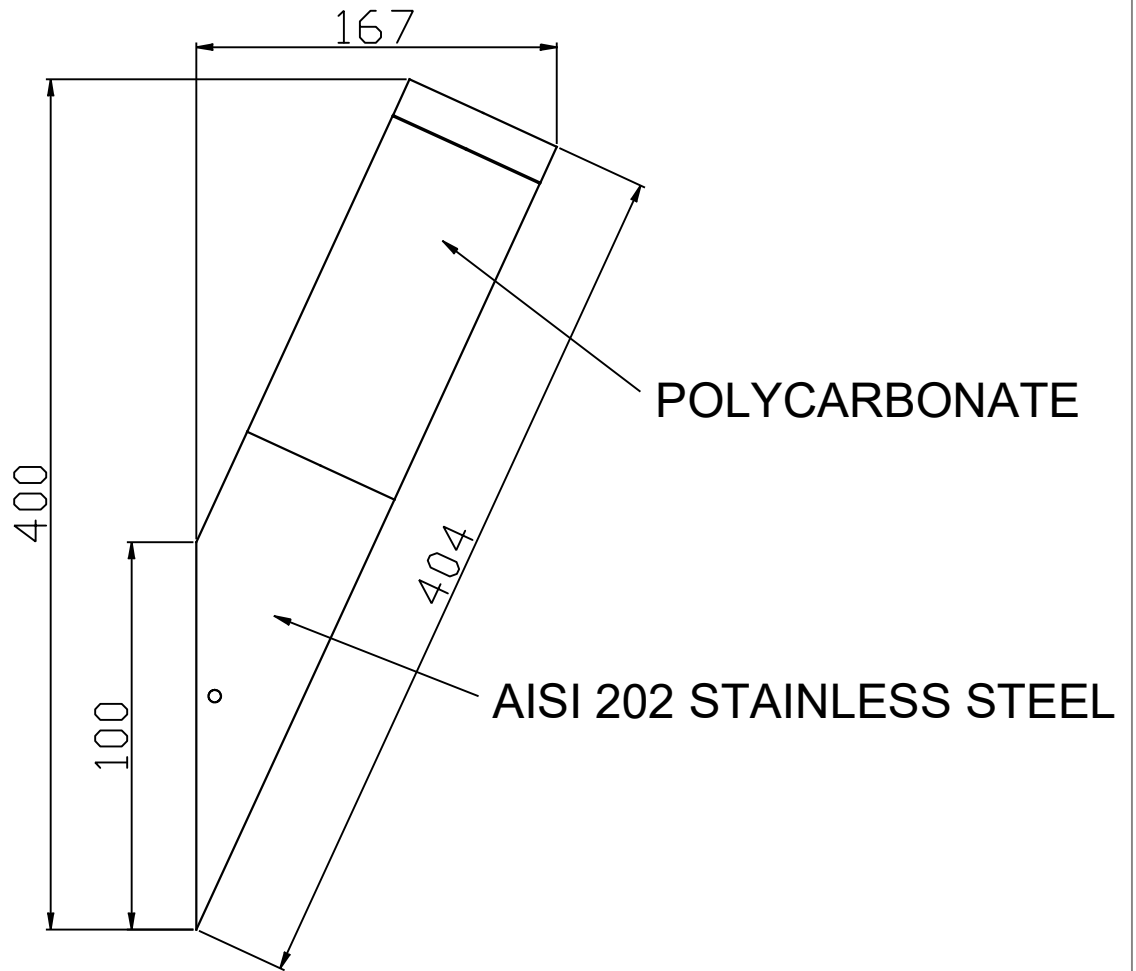



**Koral**  
PX-0098

**FOR**  
LIGHT

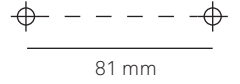
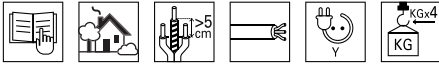

81 mm

1

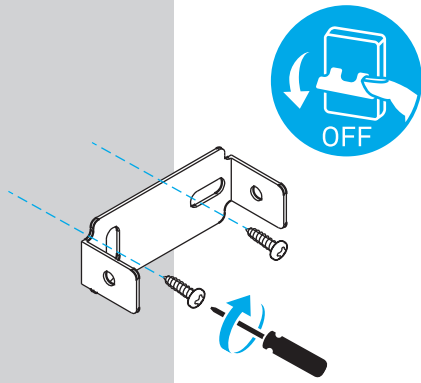

2

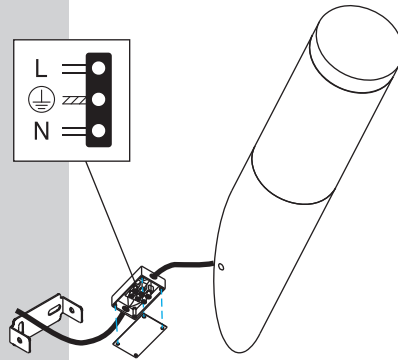

3

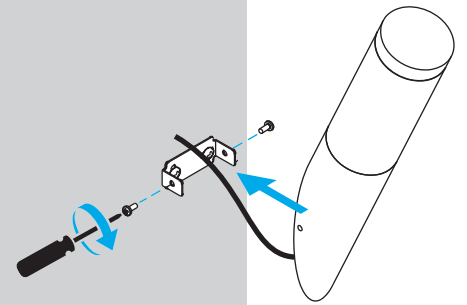

4

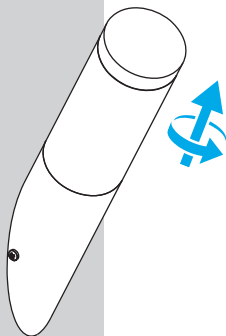

5

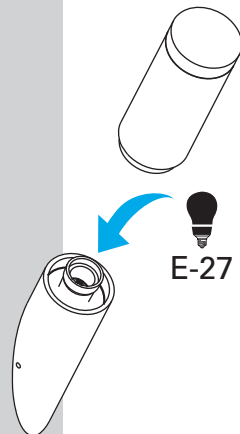

E-27

6

