



**Hide Ø105mm**

**TC-0215-BLA**

Downlight Hide Ø105mm LED 7.8W LED neutral-white 4000K ON-OFF White IN IP20 / OUT IP54 890.00

**TECHNICAL FEATURES**



IN IP20 / OUT IP54



28

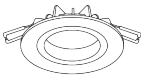

Ø105



Luminaire total power : 7.8W

Real lumens : 394

Nominal lumens : 890

Real lm/W : 51

Lens / reflector angle : HORIZONTAL 136°

Structure material : Aluminium

Structure finish : White

Diffuser material : Glass

Diffuser finish : Transparent

Voltage / frequency : 100-240V/50-60Hz

Dimming protocol : ON-OFF

Power Factor : 0.90

Useful life : 36.000h L70B30

Warranty : 5 Years

Easily recyclable luminaire

**LUMINOTECHNIC FEATURES**

CRI: 80

MacAdam steps: 3

Photobiological risk: RG0

Lampholder	Quantity	Light source power (W)	Correlated Colour Temperature (CCT)
LED	1	6.5W	LED neutral-white 4000K

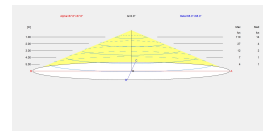
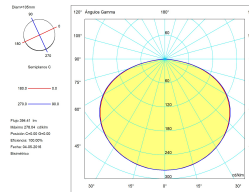

**LOGISTICS**

Net weight (kg): 0.17

Packaged weight (kg): 0.26

Packaging: 125mm x 60mm x 130mm



20 Un

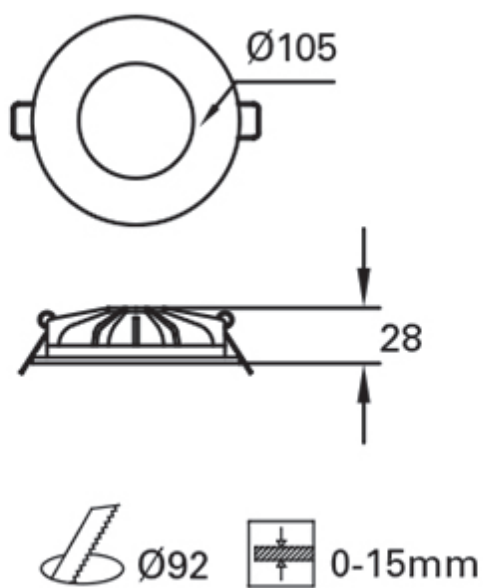

**Luminaire**

Code TC-0215-BLA  
 Name Downlight led 6.5W dif. opal

**Measur.**

Code TC-0175-BLA  
 Name Downlight led 6.5W dif. opal

Luminaire Flux	394.41 lm	Luminaire Power	7.00 W	Efficacy	56.34 lm/W	Efficiency	100.00%
Lamps Flux	394.41 lm	Maximum value	278.04 cd/klm	Position	C=0.00 G=0.00	CG	Double Symmetrical
Round Luminaire Round Luminous Area	Diam. 105 mm Diam. 58 mm	Height	2 mm	Height	0 mm		
Horizontal Luminous Area Emitting area on Plane 0° Emitting area on Plane 90°	0.002642 m2 0.000000 m2 0.000000 m2	Emitting area on Plane 180° Emitting area on Plane 270° Glare area at 76°			0.000000 m2 0.000000 m2 0.000639 m2		
Coordinate system Date Measurement Distance	CG 04-05-2016 0.00	Symmetry Type Maximum Gamma Angle Measurement Flux			Double Symmetrical 90 394.41 lm		
Operator Temperature Humidity Notes	Asselum T3 25.00 °C 60.00 %	Source Voltage [V] Source current [A] Photocell					

Line		Code	Luminaire Lamps		Flux [lm]	Pow. [W]	Q.ty
		TC-0215-BLA	Name	TC-0215-BLA - 7.00 W	394.41	7.00	1
C.I.E.	40 73 94 100 100		D DIN 5040		A20		
F UTE	1.00 G		B NBN		BZ 5		

Diam=105mm

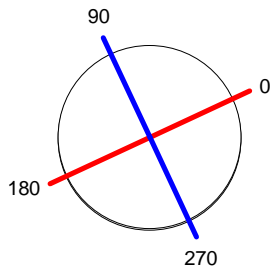

C Halfplanes  
 180.0 — 0.0  
 270.0 — 90.0

ULOR 0.00 %  
 DLOR 100.00 %  
 RN 0.00 %

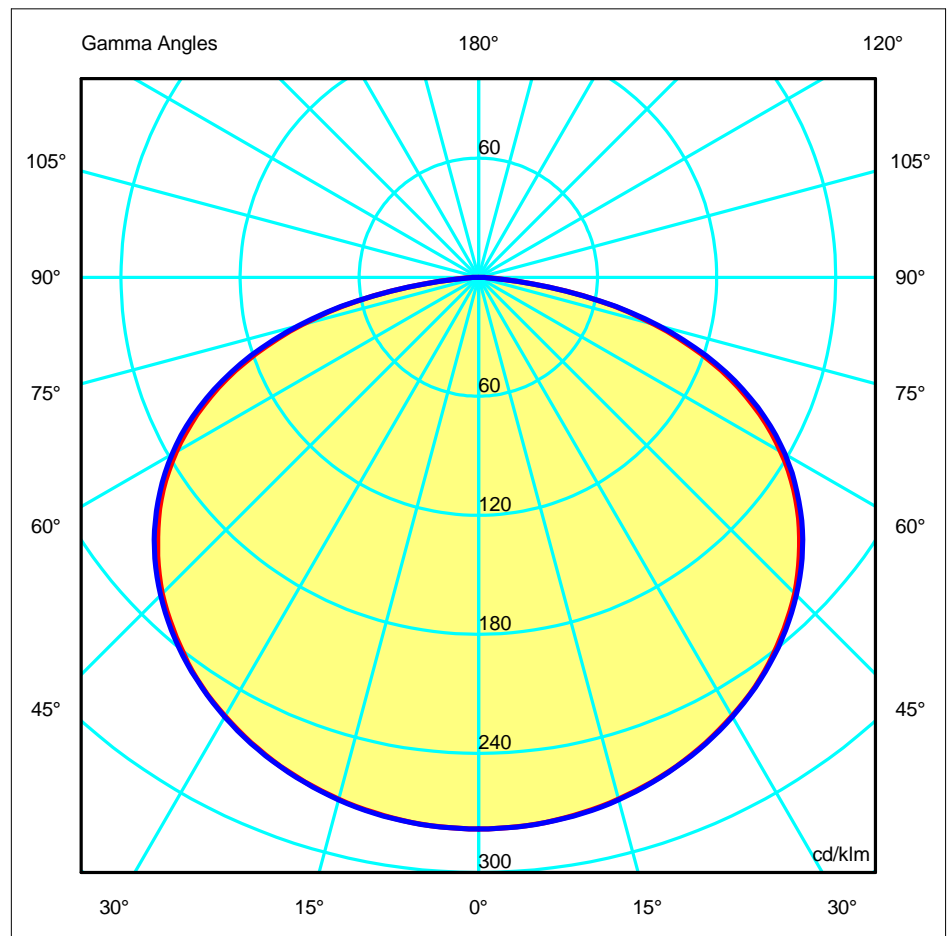



**Luminaire**

Code TC-0215-BLA  
 Name Downlight led 6.5W dif. opal

**Measur.**

Code TC-0175-BLA  
 Name Downlight led 6.5W dif. opal

Luminaire Flux	394.41 lm	Luminaire Power	7.00 W	Efficacy	56.34 lm/W	Efficiency	100.00%
Lamps Flux	394.41 lm	Maximum value	278.04 cd/klm	Position	C=0.00 G=0.00	CG	Double Symmetrical

**Luminous Intensity Table cd/klm Table 1/1**

	C 0.00	C 15.00	C 30.00	C 45.00	C 60.00	C 75.00	C 90.00
G 0.0	278.04	278.04	278.04	278.04	278.04	278.04	278.04
G 5.0	277.41	277.40	277.36	277.41	277.49	277.38	277.44
G 10.0	275.43	275.58	275.54	275.57	275.55	275.53	275.69
G 15.0	272.24	272.54	272.49	272.51	272.55	272.43	272.61
G 20.0	267.91	268.17	268.13	268.24	268.15	268.19	268.13
G 25.0	262.28	262.56	262.47	262.62	262.55	262.56	262.64
G 30.0	255.28	255.67	255.61	255.70	255.64	255.78	255.74
G 35.0	247.15	247.44	247.32	247.53	247.37	247.61	247.47
G 40.0	236.76	237.43	237.37	237.67	237.63	237.75	237.89
G 45.0	225.24	225.68	225.71	226.11	226.05	226.56	226.43
G 50.0	211.04	211.75	211.88	212.52	212.86	213.03	213.09
G 55.0	195.12	195.40	195.83	196.50	196.62	197.18	197.07
G 60.0	175.78	175.95	176.30	177.06	177.68	178.03	178.28
G 65.0	152.66	152.99	153.17	154.24	154.39	155.22	155.24
G 70.0	124.88	125.21	125.03	126.15	126.62	127.90	127.44
G 75.0	91.73	91.88	91.51	93.02	93.06	94.09	94.04
G 80.0	53.38	53.04	53.20	54.11	53.75	55.00	53.81
G 85.0	14.59	14.44	14.24	14.65	13.66	13.86	13.14
G 90.0	2.20	2.08	2.05	2.23	2.20	2.34	2.36

**Luminaire**

Code TC-0215-BLA  
 Name Downlight led 6.5W dif. opal

**Measur.**

Code TC-0175-BLA  
 Name Downlight led 6.5W dif. opal

Luminaire Flux	394.41 lm	Luminaire Power	7.00 W	Efficacy	56.34 lm/W	Efficiency	100.00%
Lamps Flux	394.41 lm	Maximum value	278.04 cd/klm	Position	C=0.00 G=0.00	CG	Double Symmetrical

Diam=105mm

C Halfplanes

180.0 ——— 0.0  
 270.0 ——— 90.0

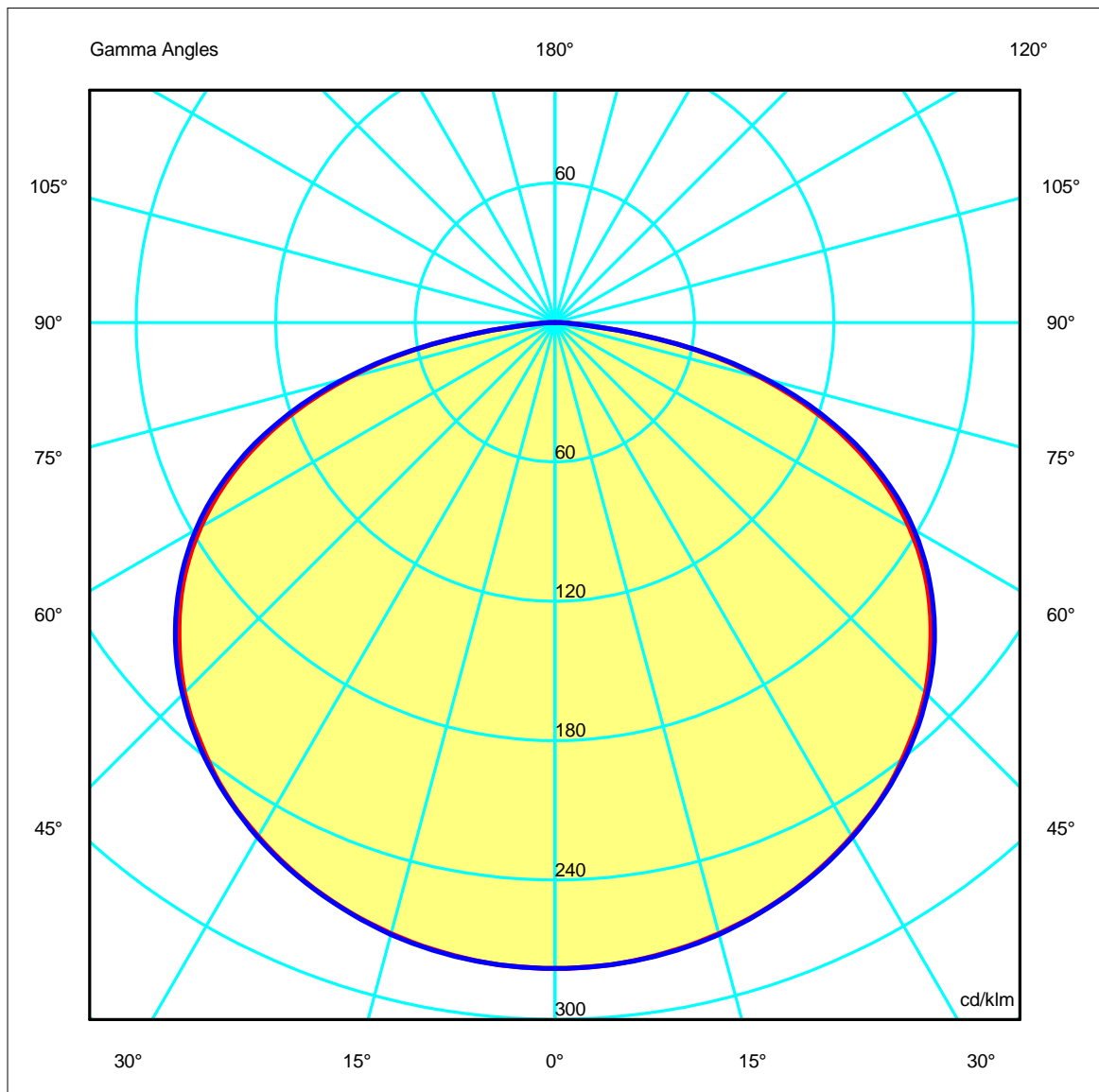
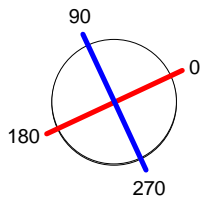

**Luminaire**

Code TC-0215-BLA  
Name Downlight led 6.5W dif. opal

**Measur.**

Code TC-0175-BLA  
Name Downlight led 6.5W dif. opal

Luminaire Flux	394.41 lm	Luminaire Power	7.00 W	Efficacy	56.34 lm/W	Efficiency	100.00%
Lamps Flux	394.41 lm	Maximum value	278.04 cd/klm	Position	C=0.00 G=0.00	CG	Double Symmetrical

Width at 50.00 % of Max Intensity

H[m]	1.00	2.00	3.00	4.00	5.00	H[m]	1.00	2.00	3.00	4.00	5.00
OA	2.42	4.84	7.27	9.69	12.11	OC	2.48	4.96	7.44	9.91	12.39
OB	2.42	4.84	7.27	9.69	12.11	OD	2.48	4.96	7.44	9.91	12.39

	Luminous Intensities [ cd/klm]									
	0	5	15	25	35	45	55	65	75	85
OA	109.66	109.41	107.37	103.45	97.48	88.84	76.96	60.21	36.18	5.76
OB	109.66	109.41	107.37	103.45	97.48	88.84	76.96	60.21	36.18	5.76
OC	109.66	109.43	107.52	103.59	97.61	89.31	77.73	61.23	37.09	5.18
OD	109.66	109.43	107.52	103.59	97.61	89.31	77.73	61.23	37.09	5.18

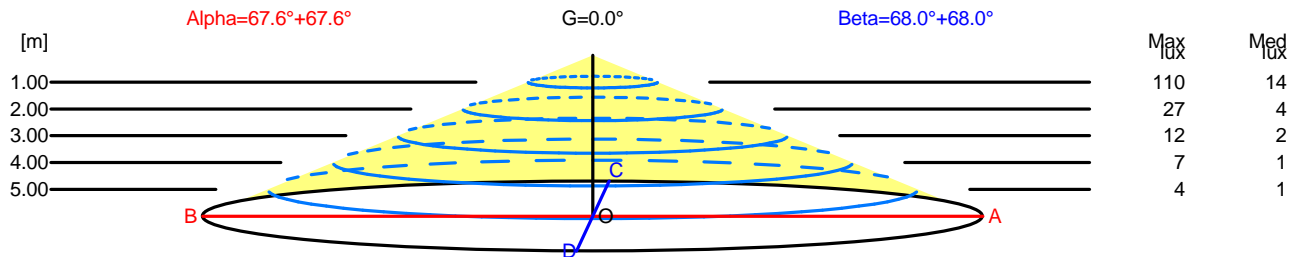

H[m]	D[m]	Max lux	Med lux	Alpha=67.6°+67.6°	G=0.0
1.00	4.84	110	14		
2.00	9.69	27	4		
3.00	14.53	12	2		
4.00	19.38	7	1		
5.00	24.22	4	1		

H[m]	D[m]	Max lux	Med lux	Beta=68.0°+68.0°	G=0.0
1.00	4.96	110	14		
2.00	9.91	27	4		
3.00	14.87	12	2		
4.00	19.83	7	1		
5.00	24.78	4	1		

**Luminaire**

Code TC-0215-BLA  
Name Downlight led 6.5W dif. opal

**Measurement**

Code TC-0175-BLA  
Name Downlight led 6.5W dif. opal

Luminaire Flux	394.41 lm	Luminaire Power	7.00 W	Efficacy	56.34 lm/W	Efficiency	100.00%
Lamps Flux	394.41 lm	Maximum value	278.04 cd/klm	Position	C=0.00 G=0.00	CG	Double Symmetrical

**UGR**  
S = 0.250

Reflectancies										
Ceiling/Cavity	0.7	0.7	0.5	0.5	0.3	0.7	0.7	0.5	0.5	0.3
Walls	0.5	0.3	0.5	0.3	0.3	0.5	0.3	0.5	0.3	0.3
WorkingPlane	0.2	0.2	0.2	0.2	0.2	0.2	0.2	0.2	0.2	0.2
RoomDimensions	ViewedCrosswise					ViewedEndwise				
x=2H y=2H	26.4	27.9	26.7	28.1	28.4	26.5	27.9	26.8	28.2	28.4
x=2H y=3H	28.6	29.9	28.9	30.1	30.5	28.7	30.0	29.0	30.2	30.5
x=2H y=4H	29.4	30.7	29.8	31.0	31.4	29.5	30.8	29.9	31.1	31.4
x=2H y=6H	30.1	31.2	30.4	31.5	31.9	30.2	31.3	30.5	31.6	31.9
x=2H y=8H	30.2	31.3	30.6	31.6	32.1	30.3	31.4	30.7	31.7	32.1
x=2H y=12H	30.3	31.3	30.6	31.6	32.1	30.4	31.4	30.7	31.7	32.1
x=4H y=2H	27.4	28.6	27.7	28.9	29.3	27.4	28.7	27.8	29.0	29.3
x=4H y=3H	29.7	30.7	30.1	31.0	31.5	29.7	30.8	30.1	31.1	31.5
x=4H y=4H	30.7	31.6	31.1	31.9	32.4	30.8	31.7	31.2	32.0	32.4
x=4H y=6H	31.4	32.2	31.8	32.6	33.1	31.5	32.3	31.9	32.7	33.1
x=4H y=8H	31.6	32.3	32.0	32.7	33.3	31.7	32.5	32.1	32.8	33.3
x=4H y=12H	31.7	32.3	32.1	32.8	33.3	31.8	32.4	32.2	32.9	33.3
x=8H y=4H	31.1	31.9	31.5	32.3	32.8	31.2	32.0	31.6	32.3	32.8
x=8H y=6H	32.0	32.6	32.4	33.0	33.6	32.1	32.7	32.5	33.1	33.6
x=8H y=8H	32.2	32.8	32.7	33.2	33.8	32.3	32.9	32.8	33.3	33.8
x=8H y=12H	32.3	32.8	32.8	33.3	33.9	32.4	32.9	32.9	33.4	33.9
x=12H y=4H	31.2	31.8	31.6	32.3	32.8	31.2	31.9	31.7	32.3	32.8
x=12H y=6H	32.0	32.6	32.5	33.0	33.6	32.1	32.7	32.6	33.1	33.6
x=12H y=8H	32.3	32.8	32.8	33.3	33.9	32.4	32.9	32.9	33.4	33.9

**Luminaire**

Code TC-0215-BLA  
 Name Downlight led 6.5W dif. opal

**Measur.**

Code TC-0175-BLA  
 Name Downlight led 6.5W dif. opal

Luminaire Flux	394.41 lm	Luminaire Power	7.00 W	Efficacy	56.34 lm/W	Efficiency	100.00%
Lamps Flux	394.41 lm	Maximum value	278.04 cd/klm	Position	C=0.00 G=0.00	CG	Double Symmetrical

Diam=105mm

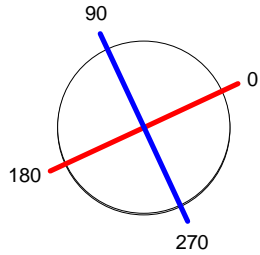

C Halfplanes

180.0 ———— 0.0  
 270.0 ———— 90.0

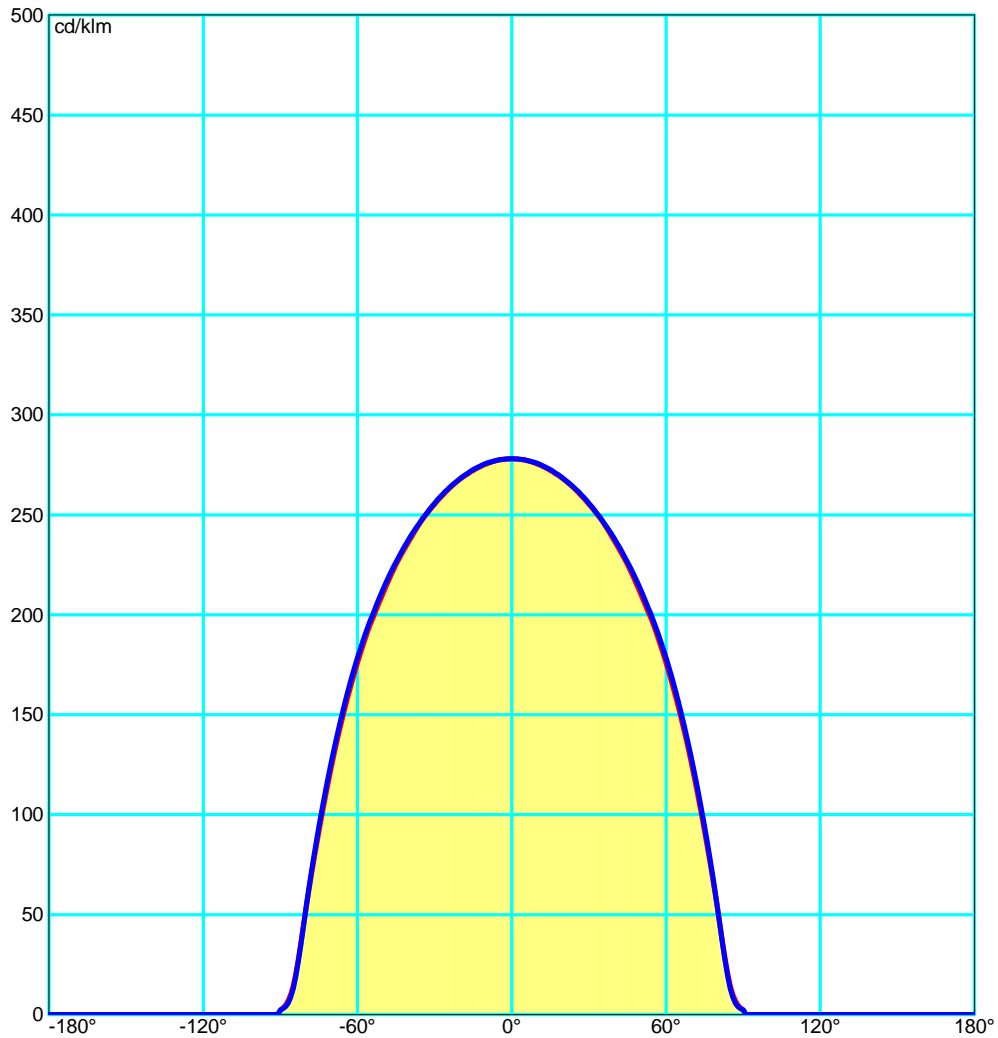



**Luminaire**

Code TC-0215-BLA  
 Name Downlight led 6.5W dif. opal

**Measur.**

Code TC-0175-BLA  
 Name Downlight led 6.5W dif. opal

Luminaire Flux	394.41 lm	Luminaire Power	7.00 W	Efficacy	56.34 lm/W	Efficiency	100.00%
Lamps Flux	394.41 lm	Maximum value	278.04 cd/klm	Position	C=0.00 G=0.00	CG	Double Symmetrical

Luminance

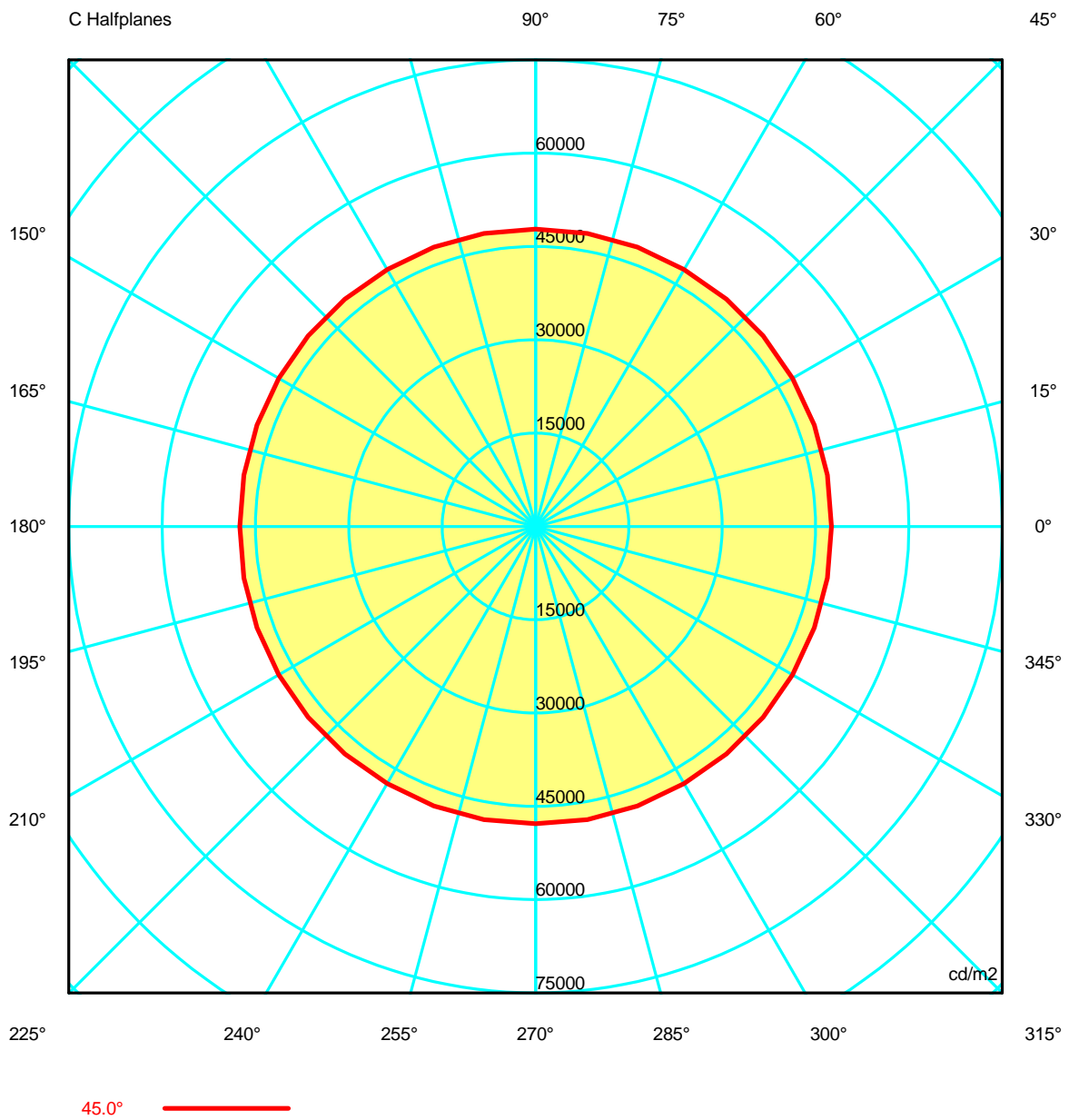



**Luminaire**

Code TC-0215-BLA  
 Name Downlight led 6.5W dif. opal

**Measur.**

Code TC-0175-BLA  
 Name Downlight led 6.5W dif. opal

Luminaire Flux	394.41 lm	Luminaire Power	7.00 W	Efficacy	56.34 lm/W	Efficiency	100.00%
Lamps Flux	394.41 lm	Maximum value	278.04 cd/klm	Position	C=0.00 G=0.00	CG	Double Symmetrical

**Luminance cd/m2 Table 1/3**

	C 0.00	C 10.00	C 20.00	C 30.00	C 40.00	C 50.00	C 60.00	C 70.00	C 80.00	C 90.00	C 100.00	C 110.00	C 120.00
G 0.0	41506.07	41506.07	41506.07	41506.07	41506.07	41506.07	41506.07	41506.07	41506.07	41506.07	41506.07	41506.07	41506.07
G 5.0	41569.27	41568.51	41566.34	41563.20	41565.69	41576.07	41582.53	41570.39	41564.51	41574.49	41564.51	41570.39	41582.53
G 10.0	41751.03	41768.92	41772.87	41767.65	41770.15	41772.24	41768.57	41764.55	41771.23	41789.19	41771.23	41764.55	41768.57
G 15.0	42073.40	42109.68	42117.30	42112.56	42111.50	42119.57	42122.29	42107.37	42107.20	42131.55	42107.20	42107.37	42122.29
G 20.0	42560.81	42593.63	42601.45	42595.50	42607.50	42609.78	42599.19	42601.98	42603.60	42595.98	42603.60	42601.98	42599.19
G 25.0	43200.84	43239.72	43244.17	43231.42	43248.13	43252.37	43244.49	43243.43	43250.51	43259.32	43250.51	43243.43	43244.49
G 30.0	44003.14	44056.68	44071.10	44060.48	44071.52	44073.11	44065.10	44081.64	44092.02	44082.35	44092.02	44081.64	44065.10
G 35.0	45040.47	45085.72	45086.98	45070.89	45099.43	45101.45	45079.71	45109.24	45125.42	45098.87	45125.42	45109.24	45079.71
G 40.0	46137.58	46240.99	46270.25	46257.25	46296.65	46319.09	46307.24	46319.44	46340.98	46357.34	46340.98	46319.44	46307.24
G 45.0	47551.55	47625.12	47646.30	47650.28	47713.40	47733.50	47722.82	47795.23	47837.55	47802.11	47837.55	47795.23	47722.82
G 50.0	49011.73	49139.27	49190.50	49207.74	49301.86	49392.03	49434.20	49462.49	49479.98	49488.37	49479.98	49462.49	49434.20
G 55.0	50782.43	50828.67	50882.45	50968.39	51096.05	51154.94	51171.67	51273.84	51330.17	51289.43	51330.17	51273.84	51171.67
G 60.0	52481.34	52512.95	52554.52	52635.93	52783.79	52934.82	53046.76	53123.66	53179.71	53227.29	53179.71	53123.66	53046.76
G 65.0	53924.39	54016.83	54040.21	54104.55	54370.93	54515.53	54535.43	54733.11	54830.56	54834.12	54830.56	54733.11	54535.43
G 70.0	54504.27	54639.93	54622.46	54571.48	54897.17	55135.26	55267.21	55671.48	55845.77	55621.57	55845.77	55671.48	55267.21
G 75.0	52908.98	53029.89	52921.18	52779.48	53382.07	53659.48	53676.66	54067.08	54342.17	54239.56	54342.17	54067.08	53676.66
G 80.0	45892.73	45680.68	45543.57	45730.92	46361.48	46411.97	46207.10	46988.21	47196.97	46259.16	47196.97	46988.21	46207.10
G 85.0	24994.29	24885.10	24519.15	24383.78	25052.17	24621.66	23403.82	23583.32	23550.54	22506.55	23550.54	23583.32	23403.82
G 90.0	0.00	0.00	0.00	0.00	0.00	0.00	0.00	0.00	0.00	0.00	0.00	0.00	0.00



**Luminaire**

Code TC-0215-BLA  
 Name Downlight led 6.5W dif. opal

**Measur.**

Code TC-0175-BLA  
 Name Downlight led 6.5W dif. opal

Luminaire Flux	394.41 lm	Luminaire Power	7.00 W	Efficacy	56.34 lm/W	Efficiency	100.00%
Lamps Flux	394.41 lm	Maximum value	278.04 cd/klm	Position	C=0.00 G=0.00	CG	Double Symmetrical

**Luminance cd/m2 Table 2/3**

	C 130.00	C 140.00	C 150.00	C 160.00	C 170.00	C 180.00	C 190.00	C 200.00	C 210.00	C 220.00	C 230.00	C 240.00	C 250.00
G 0.0	41506.07	41506.07	41506.07	41506.07	41506.07	41506.07	41506.07	41506.07	41506.07	41506.07	41506.07	41506.07	41506.07
G 5.0	41576.07	41565.69	41563.20	41566.34	41568.51	41569.27	41568.51	41566.34	41563.20	41565.69	41576.07	41582.53	41570.39
G 10.0	41772.24	41770.15	41767.65	41772.87	41768.92	41751.03	41768.92	41772.87	41767.65	41770.15	41772.24	41768.57	41764.55
G 15.0	42119.57	42111.50	42112.56	42117.30	42109.68	42073.40	42109.68	42117.30	42112.56	42111.50	42119.57	42122.29	42107.37
G 20.0	42609.78	42607.50	42595.50	42601.45	42593.63	42560.81	42593.63	42601.45	42595.50	42607.50	42609.78	42599.19	42601.98
G 25.0	43252.37	43248.13	43231.42	43244.17	43239.72	43200.84	43239.72	43244.17	43231.42	43248.13	43252.37	43244.49	43243.43
G 30.0	44073.11	44071.52	44060.48	44071.10	44056.68	44003.14	44056.68	44071.10	44060.48	44071.52	44073.11	44065.10	44081.64
G 35.0	45101.45	45099.43	45070.89	45086.98	45085.72	45040.47	45085.72	45086.98	45070.89	45099.43	45101.45	45079.71	45109.24
G 40.0	46319.09	46296.65	46257.25	46270.25	46240.99	46137.58	46240.99	46270.25	46257.25	46296.65	46319.09	46307.24	46319.44
G 45.0	47733.50	47713.40	47650.28	47646.30	47625.12	47551.55	47625.12	47646.30	47650.28	47713.40	47733.50	47722.82	47795.23
G 50.0	49392.03	49301.86	49207.74	49190.50	49139.27	49011.73	49139.27	49190.50	49207.74	49301.86	49392.03	49434.20	49462.49
G 55.0	51154.94	51096.05	50968.39	50882.45	50828.67	50782.43	50828.67	50882.45	50968.39	51096.05	51154.94	51171.67	51273.84
G 60.0	52934.82	52783.79	52635.93	52554.52	52512.95	52481.34	52512.95	52554.52	52635.93	52783.79	52934.82	53046.76	53123.66
G 65.0	54515.53	54370.93	54104.55	54040.21	54016.83	53924.39	54016.83	54040.21	54104.55	54370.93	54515.53	54535.43	54733.11
G 70.0	55135.26	54897.17	54571.48	54622.46	54639.93	54504.27	54639.93	54622.46	54571.48	54897.17	55135.26	55267.21	55671.48
G 75.0	53659.48	53382.07	52779.48	52921.18	53029.89	52908.98	53029.89	52921.18	52779.48	53382.07	53659.48	53676.66	54067.08
G 80.0	46411.97	46361.48	45730.92	45543.57	45680.68	45892.73	45680.68	45543.57	45730.92	46361.48	46411.97	46207.10	46988.21
G 85.0	24621.66	25052.17	24383.78	24519.15	24885.10	24994.29	24885.10	24519.15	24383.78	25052.17	24621.66	23403.82	23583.32
G 90.0	0.00	0.00	0.00	0.00	0.00	0.00	0.00	0.00	0.00	0.00	0.00	0.00	0.00



**Luminaire**

Code TC-0215-BLA  
 Name Downlight led 6.5W dif. opal

**Measur.**

Code TC-0175-BLA  
 Name Downlight led 6.5W dif. opal

Luminaire Flux	394.41 lm	Luminaire Power	7.00 W	Efficacy	56.34 lm/W	Efficiency	100.00%
Lamps Flux	394.41 lm	Maximum value	278.04 cd/klm	Position	C=0.00 G=0.00	CG	Double Symmetrical

**Luminance cd/m2 Table 3/3**

	C 260.00	C 270.00	C 280.00	C 290.00	C 300.00	C 310.00	C 320.00	C 330.00	C 340.00	C 350.00
G 0.0	41506.07	41506.07	41506.07	41506.07	41506.07	41506.07	41506.07	41506.07	41506.07	41506.07
G 5.0	41564.51	41574.49	41564.51	41570.39	41582.53	41576.07	41565.69	41563.20	41566.34	41568.51
G 10.0	41771.23	41789.19	41771.23	41764.55	41768.57	41772.24	41770.15	41767.65	41772.87	41768.92
G 15.0	42107.20	42131.55	42107.20	42107.37	42122.29	42119.57	42111.50	42112.56	42117.30	42109.68
G 20.0	42603.60	42595.98	42603.60	42601.98	42599.19	42609.78	42607.50	42595.50	42601.45	42593.63
G 25.0	43250.51	43259.32	43250.51	43243.43	43244.49	43252.37	43248.13	43231.42	43244.17	43239.72
G 30.0	44092.02	44082.35	44092.02	44081.64	44065.10	44073.11	44071.52	44060.48	44071.10	44056.68
G 35.0	45125.42	45098.87	45125.42	45109.24	45079.71	45101.45	45099.43	45070.89	45086.98	45085.72
G 40.0	46340.98	46357.34	46340.98	46319.44	46307.24	46319.09	46296.65	46257.25	46270.25	46240.99
G 45.0	47837.55	47802.11	47837.55	47795.23	47722.82	47733.50	47713.40	47650.28	47646.30	47625.12
G 50.0	49479.98	49488.37	49479.98	49462.49	49434.20	49392.03	49301.86	49207.74	49190.50	49139.27
G 55.0	51330.17	51289.43	51330.17	51273.84	51171.67	51154.94	51096.05	50968.39	50882.45	50828.67
G 60.0	53179.71	53227.29	53179.71	53123.66	53046.76	52934.82	52783.79	52635.93	52554.52	52512.95
G 65.0	54830.56	54834.12	54830.56	54733.11	54535.43	54515.53	54370.93	54104.55	54040.21	54016.83
G 70.0	55845.77	55621.57	55845.77	55671.48	55267.21	55135.26	54897.17	54571.48	54622.46	54639.93
G 75.0	54342.17	54239.56	54342.17	54067.08	53676.66	53659.48	53382.07	52779.48	52921.18	53029.89
G 80.0	47196.97	46259.16	47196.97	46988.21	46207.10	46411.97	46361.48	45730.92	45543.57	45680.68
G 85.0	23550.54	22506.55	23550.54	23583.32	23403.82	24621.66	25052.17	24383.78	24519.15	24885.10
G 90.0	0.00	0.00	0.00	0.00	0.00	0.00	0.00	0.00	0.00	0.00

**Luminaire**  
 Code TC-0215-BLA  
 Name Downlight led 6.5W dif. opal  
**Measur.**  
 Code TC-0175-BLA  
 Name Downlight led 6.5W dif. opal

Luminaire Flux	394.41 lm	Luminaire Power	7.00 W	Efficacy	56.34 lm/W	Efficiency	100.00%
Lamps Flux	394.41 lm	Maximum value	278.04 cd/klm	Position	C=0.00 G=0.00	CG	Double Symmetrical

**PERCENTAGE ISOCANDLES**

Projection: Equal Area SLI (glare) 6.6 Tight Tilting Angle:0°

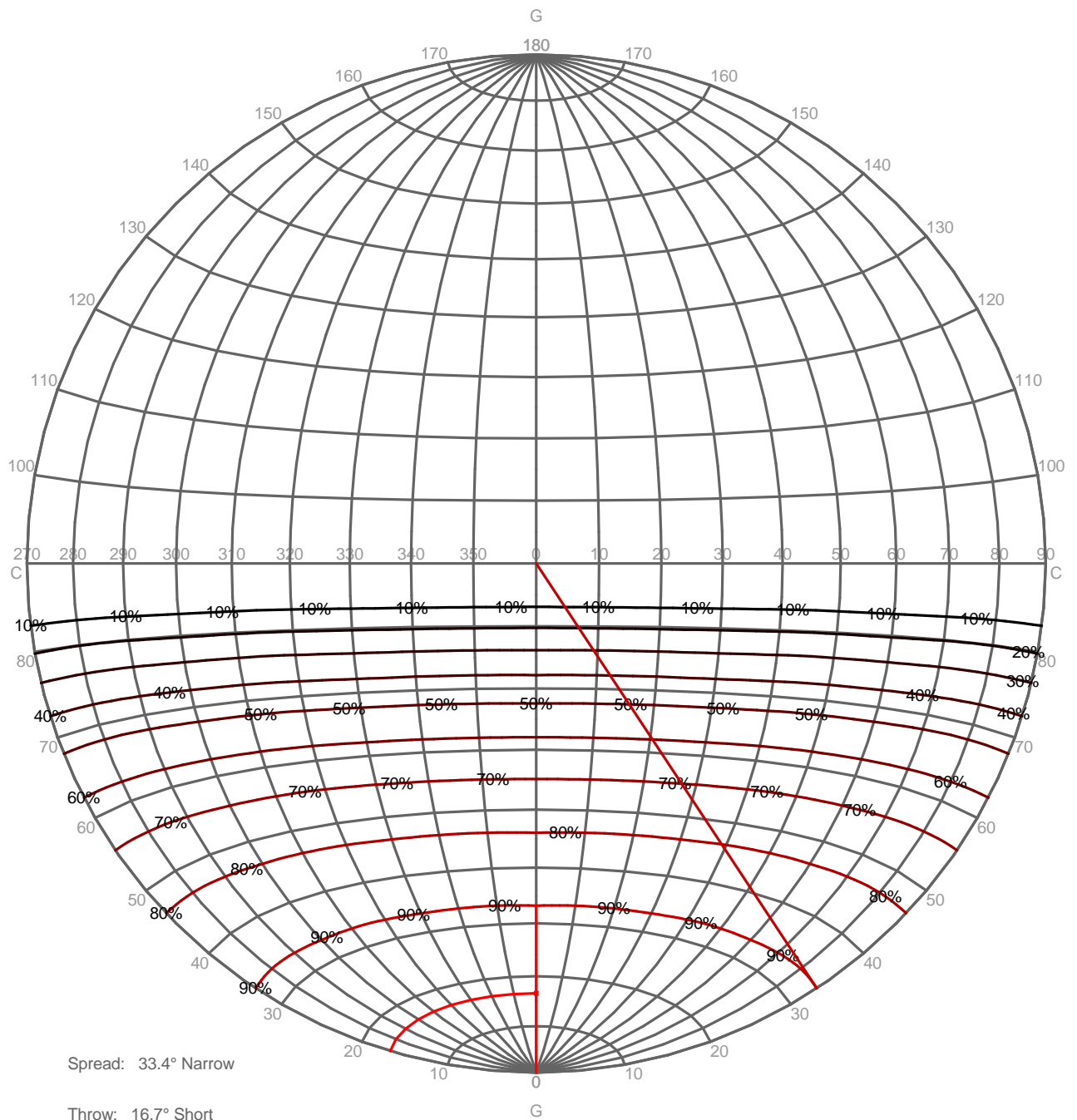

**Luminaire**

Code TC-0215-BLA  
 Name Downlight led 6.5W dif. opal

**Measur.**

Code TC-0175-BLA  
 Name Downlight led 6.5W dif. opal

Luminaire Flux	394.41 lm	Luminaire Power	7.00 W	Efficacy	56.34 lm/W	Efficiency	100.00%
Lamps Flux	394.41 lm	Maximum value	278.04 cd/klm	Position	C=0.00 G=0.00	CG	Double Symmetrical

Isolux (Floor)

Luminaire position X=0.00m Y=0.00m Z=2.50m

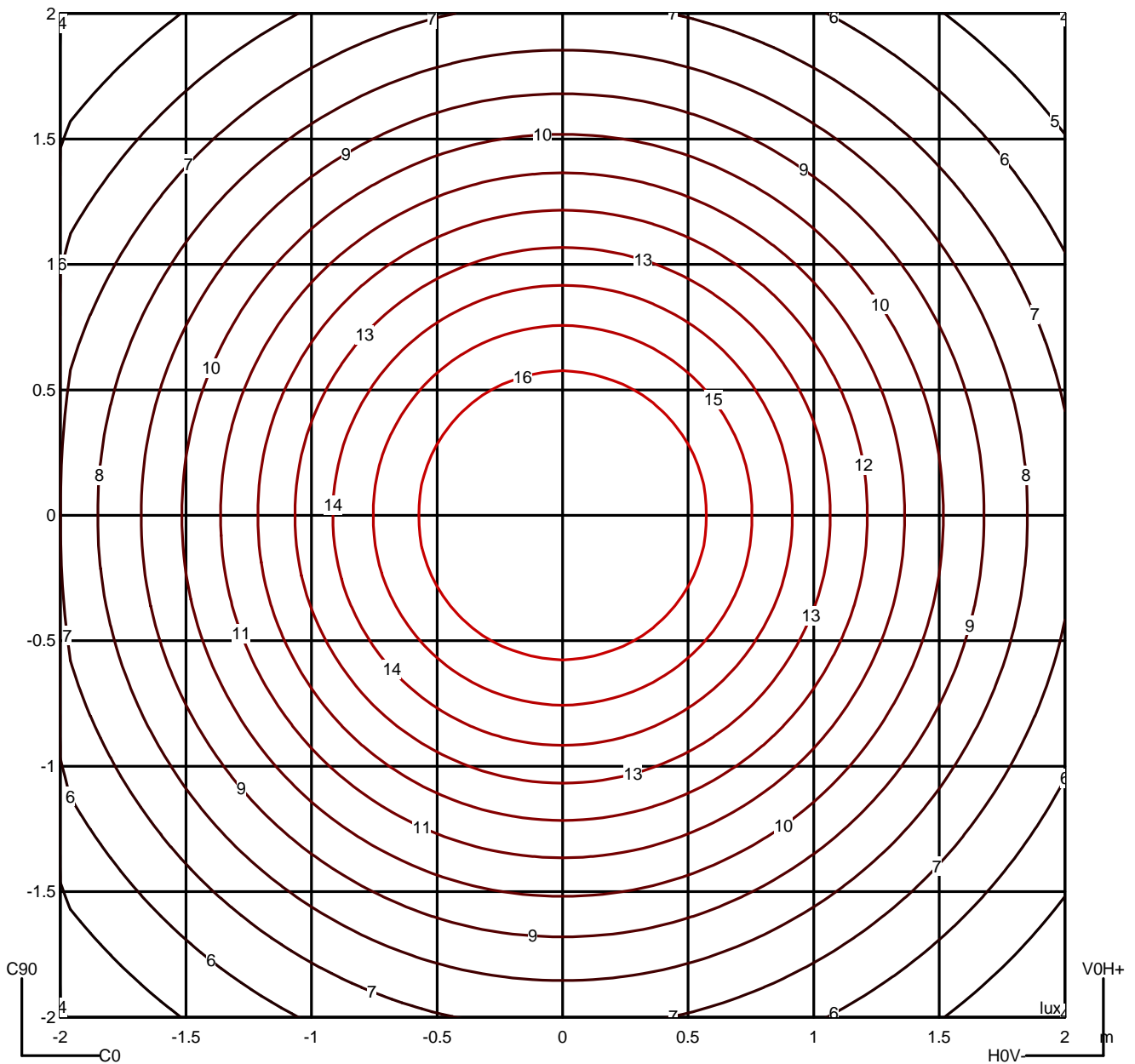

**Luminaire**

Code TC-0215-BLA  
 Name Downlight led 6.5W dif. opal

**Measur.**

Code TC-0175-BLA  
 Name Downlight led 6.5W dif. opal

Luminaire Flux	394.41 lm	Luminaire Power	7.00 W	Efficacy	56.34 lm/W	Efficiency	100.00%
Lamps Flux	394.41 lm	Maximum value	278.04 cd/klm	Position	C=0.00 G=0.00	CG	Double Symmetrical

		Average Luminance [cd/m <sup>2</sup> ]									
		45°	50°	55°	60°	65°	70°	75°	80°	85°	
0.0°	47552	49012	50782	52481	53924	54504	52909	45893	24994	---	
90.0°	47802	49488	51289	53227	54834	55622	54240	46259	22507	---	

Flush mounted or longitudinal view												
		Illumination(Ix)										
A	A	2000	1000	750	500		<300				1.15	
B	1		2000	1500	1000	750	500	<300			1.5	
C					2000		1000	500	<300		1.85	
D	2						2000	1000	500	<300	2.2	
E	3							2000	1000	500	<300	2.55

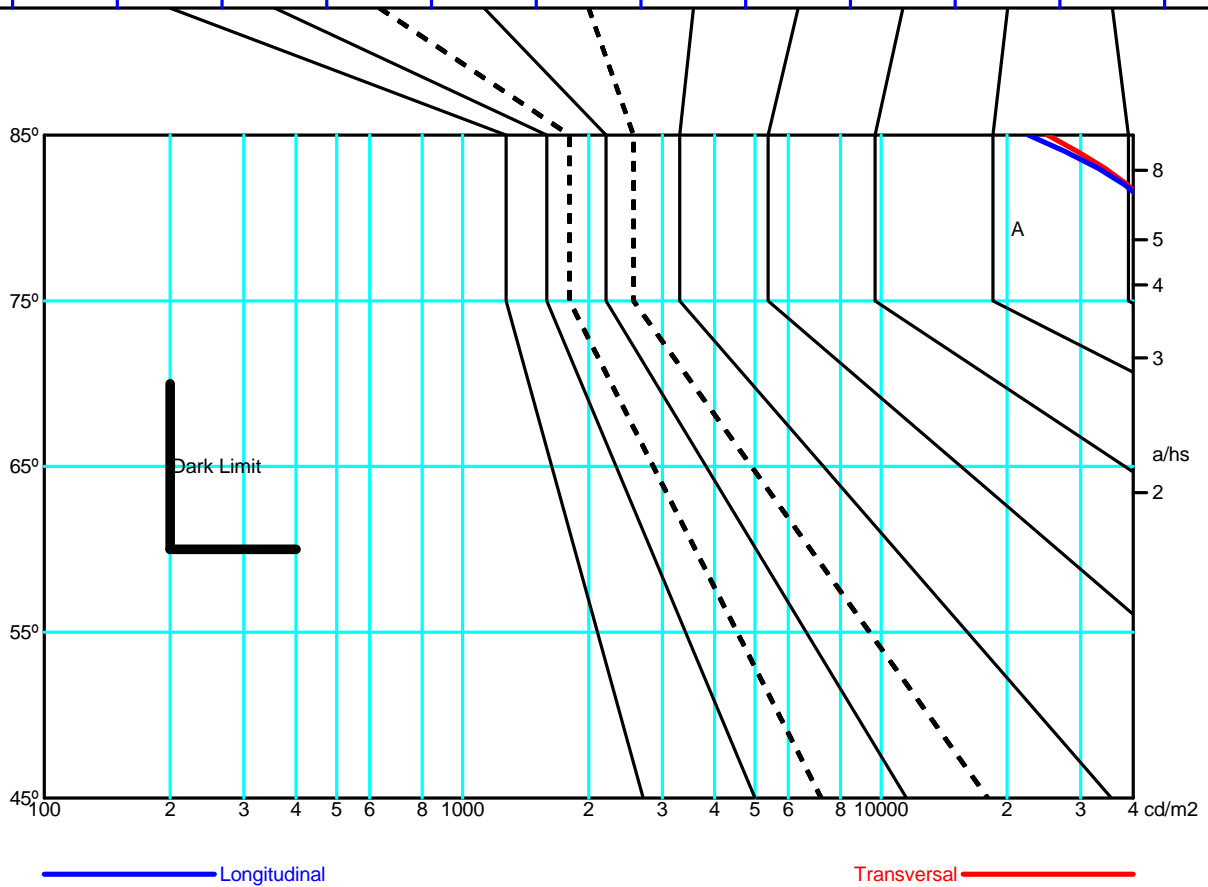

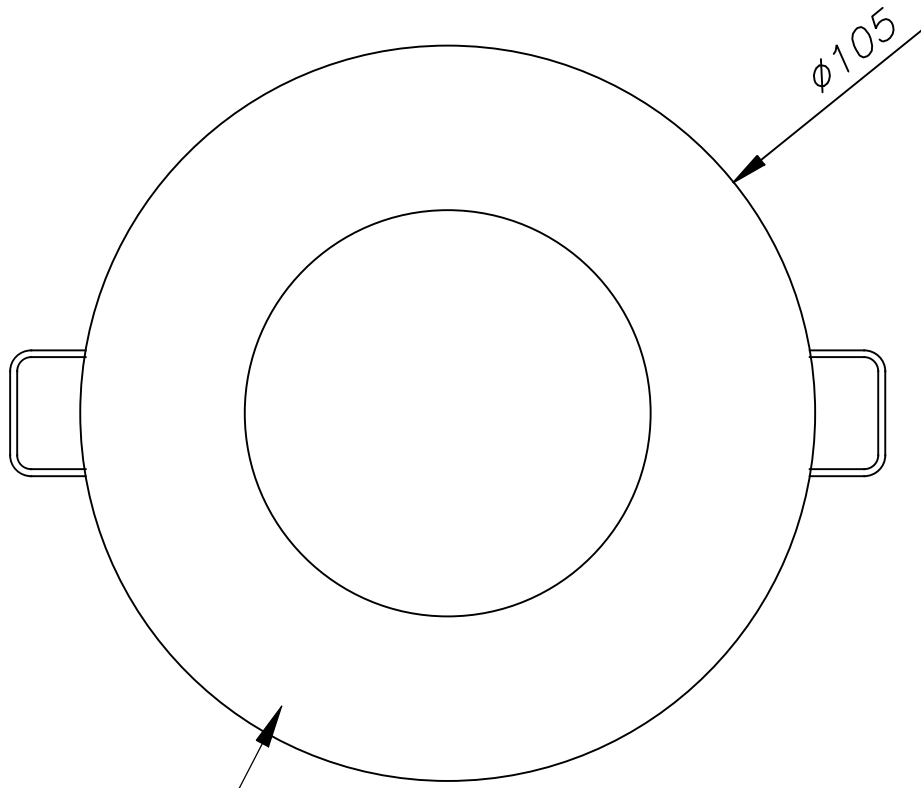

ALUMINIO INYECTADO  
INJECTED ALUMINIUM

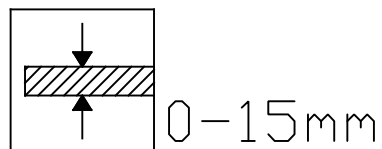
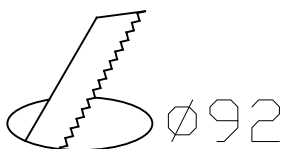
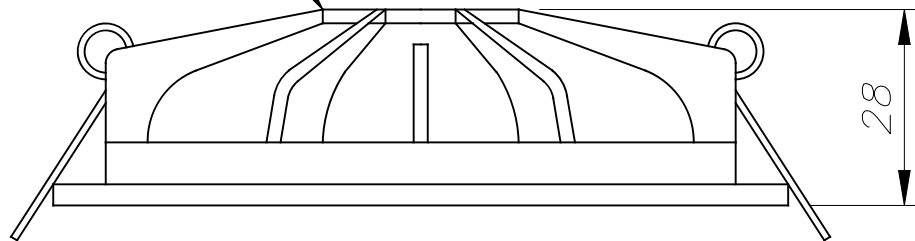

Scale 1:1



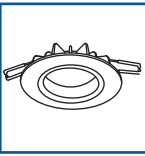

# Hide

TC-0175 TC-0176 TC-0215 TC-0216

FOR  
LIGHT

