

**CARACTERÍSTICAS TÉCNICAS**

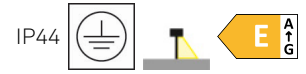
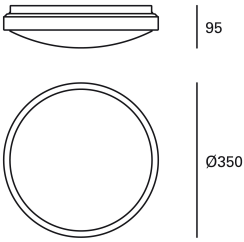

Potencia total luminaria : 18.8W

Lúmenes reales : 1346

Lúmenes nominales : 1880

Lm / W reales : 72

Ángulo Ópticas / Reflector : HORIZONTAL 113°

UGR : <=22

Material de la estructura : Aluminio

Acabado estructura : Aluminio

Material del difusor : Acrílico

Acabado difusor : Opal

Voltaje / Frecuencia : 100-240V ~ 50/60Hz

Protocolo de regulación : ON-OFF

Power Factor : 0.90

Vida útil : 36.000h L70B30

Garantía : 3 Años

Luminaria fácilmente reciclable

**CARACTERÍSTICAS LUMINOTÉCNICAS**

CRI: 80

MacAdam steps: 3

Riesgo fotobiológico: RG0

UGR

UGR Transversal: 21.5

UGR Longitudinal: 21.6

UGR	
S=0.250	
Techo / Cavidad	0.7
Paredes	0.5
Plano De Trabajo	0.2
Dimensiones de la habitación	X=4H, Y=8H
UGR Transversal	21.5
UGR Longitudinal	21.6

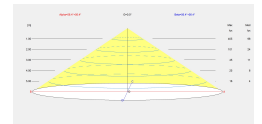
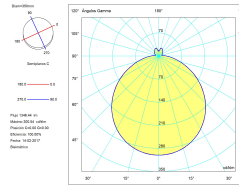

Portalámparas	Cantidad	Potencia fuente de luz (W)	Temperatura de color correlacionada (CCT)
LED	1	16.2W	3000K

**LOGÍSTICA**

Peso neto (Kg): 0.76

Peso embalado (Kg): 1.38

Embalaje: 385mm x 105mm x 380mm



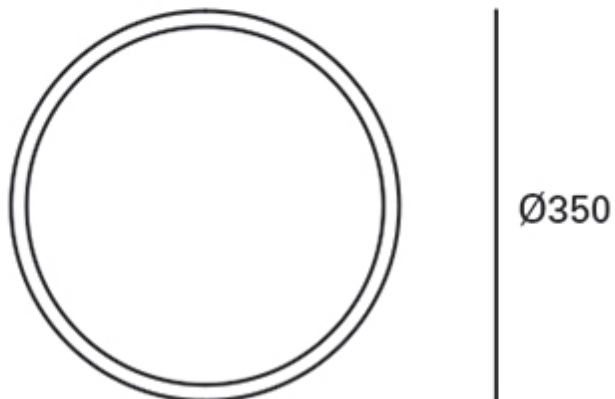

**Luminaire**

Code DE-0313-ALU  
Name Plafón TEMPO leds 18W 3000K

**Measur.**

Code CL116A17F019G  
Name Plafón TEMPO leds 13W 3000K

Luminaire Flux	1346.44 lm	Luminaire Power	18.80 W	Efficacy	71.62 lm/W	Efficiency	100.00%
Lamps Flux	1346.44 lm	Maximum value	300.54 cd/klm	Position	C=0.00 G=0.00	CG	Double Symmetrical
Round Luminaire Round Luminous Area		Diam. Diam.	350 mm 270 mm	Height Height	85 mm 30 mm		
Horizontal Luminous Area Emitting area on Plane 0° Emitting area on Plane 90°		0.057256 m2 0.008100 m2 0.008100 m2		Emitting area on Plane 180° Emitting area on Plane 270° Glare area at 76°		0.008100 m2 0.008100 m2 0.021711 m2	
Coordinate system Date Measurement Distance		CG 14-02-2017 0.00		Symmetry Type Maximum Gamma Angle Measurement Flux		Double Symmetrical 180 1346.44 lm	
Operator Temperature Humidity Notes		Asselum T2 25.00 °C 60.00 %		Source Voltage [V] Source current [A] Photocell			

Line		Code	Luminaire Lamps	Flux [lm]	Pow. [W]	Q.ty
		DE-0313-ALU	Name DE-0313-ALU	1346.44	18.40	1
C.I.E.	45 75 92 90 100		D DIN 5040	B31		
F UTE	0.90 E + 0.10 T		B NBN	BZ 5		

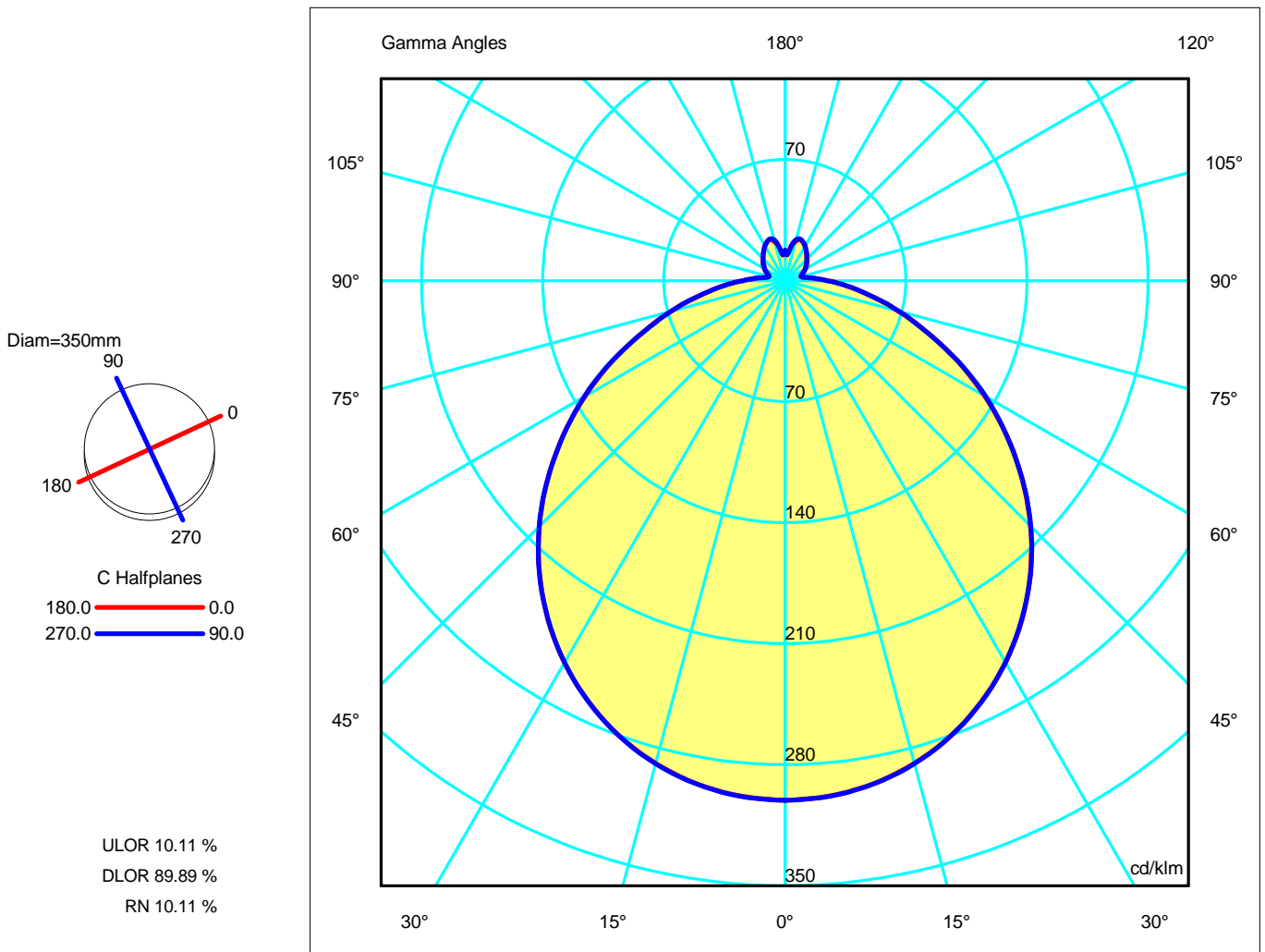



**Luminaire**

Code DE-0313-ALU  
Name Plafón TEMPO leds 18W 3000K

**Measurment**

Code CL116A17F019G  
Name Plafón TEMPO leds 13W 3000K

Luminaire Flux	1346.44 lm	Luminaire Power	18.80 W	Efficacy	71.62 lm/W	Efficiency	100.00%
Lamps Flux	1346.44 lm	Maximum value	300.54 cd/klm	Position	C=0.00 G=0.00	CG	Double Symmetrical

**Luminous Intensity Table cd/klm Table 1/1**

	C 0.00	C 15.00	C 30.00	C 45.00	C 60.00	C 75.00	C 90.00
G 0.0	300.54	300.54	300.54	300.54	300.54	300.54	300.54
G 5.0	299.09	299.24	299.25	299.27	299.22	299.20	299.24
G 10.0	295.36	295.38	295.37	295.30	295.42	295.47	295.49
G 15.0	289.00	289.06	289.08	289.02	289.08	289.04	289.20
G 20.0	280.21	280.34	280.21	279.86	280.18	280.19	280.22
G 25.0	268.69	268.70	268.48	268.75	268.84	268.85	268.78
G 30.0	255.01	254.59	254.89	254.44	254.91	254.88	254.96
G 35.0	238.99	238.76	238.66	238.97	238.80	238.74	238.77
G 40.0	220.71	220.43	220.57	219.81	220.82	220.74	220.96
G 45.0	200.80	200.64	199.23	200.46	200.90	200.60	200.97
G 50.0	179.12	178.20	179.30	178.30	179.51	179.16	179.29
G 55.0	156.78	156.67	155.90	156.45	156.70	156.57	156.48
G 60.0	133.30	132.05	133.54	131.88	133.53	133.41	133.95
G 65.0	110.11	110.32	108.28	110.32	110.50	110.08	110.42
G 70.0	87.72	86.96	87.85	86.86	88.01	87.82	87.21
G 75.0	68.16	67.85	66.59	67.86	68.15	67.84	68.09
G 80.0	50.36	49.96	50.53	49.26	50.70	50.64	50.49
G 85.0	36.20	36.20	35.65	36.21	36.13	36.29	36.22
G 90.0	24.65	24.28	24.90	24.14	24.90	24.65	24.24
G 95.0	16.29	16.18	15.70	16.21	16.42	16.32	16.40
G100.0	11.02	10.95	11.13	10.87	11.26	11.15	11.17
G105.0	9.51	9.49	9.52	9.46	9.54	9.44	9.51
G110.0	10.56	10.64	10.49	10.51	10.37	10.30	10.44
G115.0	12.15	12.03	12.13	11.89	12.00	11.87	11.86
G120.0	13.72	13.63	13.46	13.50	13.54	13.44	13.49
G125.0	15.21	14.93	14.93	14.82	15.11	14.88	14.83
G130.0	16.69	16.51	16.13	16.43	16.64	16.39	16.34
G135.0	18.08	17.85	17.62	17.80	18.15	17.89	17.73
G140.0	19.53	19.53	19.05	19.48	19.55	19.53	19.58
G145.0	21.32	21.14	20.89	21.02	21.32	21.22	21.28
G150.0	23.04	22.89	22.42	22.72	22.91	22.93	23.24
G155.0	24.60	24.14	23.96	24.08	24.50	24.43	24.65
G160.0	25.52	25.14	24.71	24.27	24.85	25.46	25.54
G165.0	23.29	23.90	23.85	23.78	23.09	23.86	24.47
G170.0	20.11	19.81	20.00	19.83	20.45	20.26	19.85
G175.0	14.88	16.06	15.06	16.00	14.78	15.92	15.08
G180.0	17.52	17.52	17.52	17.52	17.52	17.52	17.52

**Luminaire**

Code DE-0313-ALU  
 Name Plafón TEMPO leds 18W 3000K

**Measurment.**

Code CL116A17F019G  
 Name Plafón TEMPO leds 13W 3000K

Luminaire Flux	1346.44 lm	Luminaire Power	18.80 W	Efficacy	71.62 lm/W	Efficiency	100.00%
Lamps Flux	1346.44 lm	Maximum value	300.54 cd/klm	Position	C=0.00 G=0.00	CG	Double Symmetrical

Diam=350mm

C Halfplanes

180.0 ——— 0.0  
 270.0 ——— 90.0

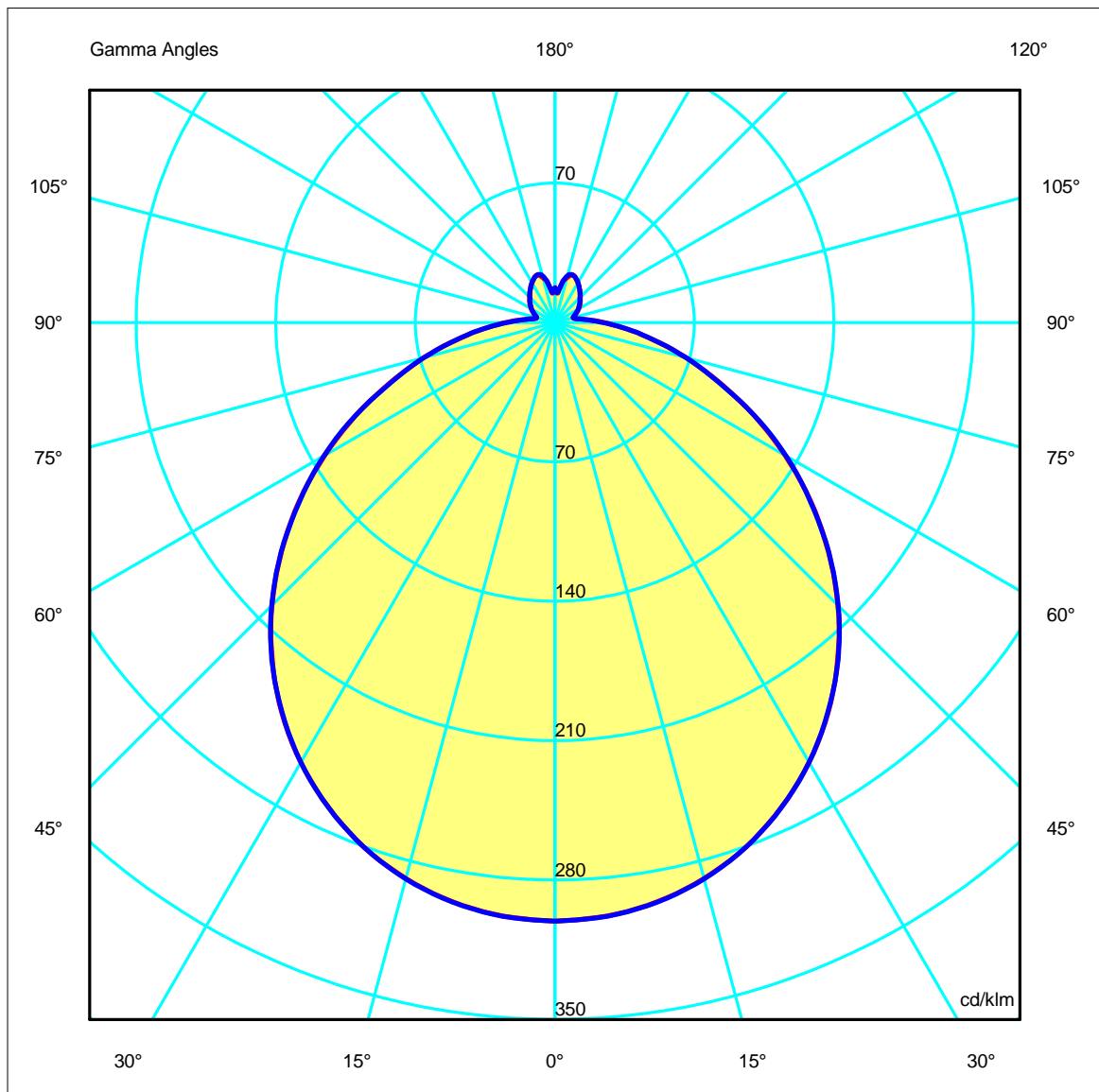
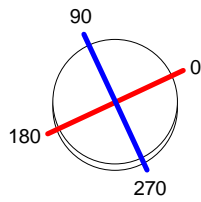

**Luminaire**

Code DE-0313-ALU  
Name Plafón TEMPO leds 18W 3000K

**Measur.**

Code CL116A17F019G  
Name Plafón TEMPO leds 13W 3000K

Luminaire Flux	1346.44 lm	Luminaire Power	18.80 W	Efficacy	71.62 lm/W	Efficiency	100.00%
Lamps Flux	1346.44 lm	Maximum value	300.54 cd/klm	Position	C=0.00 G=0.00	CG	Double Symmetrical

Width at 50.00 % of Max Intensity

H[m]	1.00	2.00	3.00	4.00	5.00	H[m]	1.00	2.00	3.00	4.00	5.00
OA	1.51	3.01	4.52	6.02	7.53	OC	1.50	3.01	4.51	6.02	7.52
OB	1.51	3.01	4.52	6.02	7.53	OD	1.50	3.01	4.51	6.02	7.52

	Luminous Intensities [ cd/klm]									
	0	5	15	25	35	45	55	65	75	85
OA	404.65	402.71	389.13	361.78	321.79	270.36	211.10	148.26	91.77	48.74
OB	404.65	402.71	389.13	361.78	321.79	270.36	211.10	148.26	91.77	48.74
OC	404.65	402.91	389.39	361.90	321.50	270.60	210.69	148.67	91.67	48.76
OD	404.65	402.91	389.39	361.90	321.50	270.60	210.69	148.67	91.67	48.76

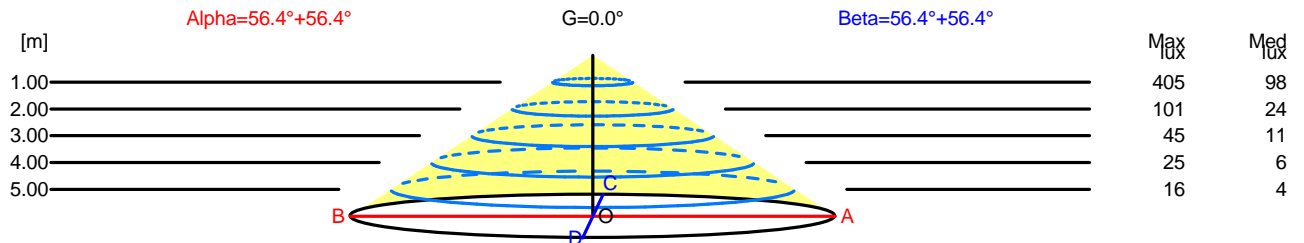

H[m]	D[m]	Max lux	Med lux	Alpha=56.4°+56.4°	G=0.0
1.00	3.01	405	98		
2.00	6.02	101	24		
3.00	9.03	45	11		
4.00	12.04	25	6		
5.00	15.05	16	4		

H[m]	D[m]	Max lux	Med lux	Beta=56.4°+56.4°	G=0.0
1.00	3.01	405	98		
2.00	6.02	101	24		
3.00	9.02	45	11		
4.00	12.03	25	6		
5.00	15.04	16	4		

**Luminaire**

 Code DE-0313-ALU  
 Name Plafón TEMPO leds 18W 3000K

**Measurement**

 Code CL116A17F019G  
 Name Plafón TEMPO leds 13W 3000K

Luminaire Flux	1346.44 lm	Luminaire Power	18.80 W	Efficacy	71.62 lm/W	Efficiency	100.00%
Lamps Flux	1346.44 lm	Maximum value	300.54 cd/klm	Position	C=0.00 G=0.00	CG	Double Symmetrical

**UGR**  
S = 0.250

Reflectancies										
Ceiling/Cavity	0.7	0.7	0.5	0.5	0.3	0.7	0.7	0.5	0.5	0.3
Walls	0.5	0.3	0.5	0.3	0.3	0.5	0.3	0.5	0.3	0.3
WorkingPlane	0.2	0.2	0.2	0.2	0.2	0.2	0.2	0.2	0.2	0.2
RoomDimensions	ViewedCrosswise					ViewedEndwise				
x=2H y=2H	17.5	18.8	18.0	19.2	19.6	17.6	18.8	18.0	19.2	19.6
x=2H y=3H	19.1	20.2	19.6	20.6	21.1	19.1	20.2	19.6	20.7	21.1
x=2H y=4H	19.8	20.8	20.3	21.3	21.8	19.8	20.8	20.3	21.3	21.8
x=2H y=6H	20.4	21.4	20.9	21.8	22.4	20.4	21.4	20.9	21.8	22.4
x=2H y=8H	20.6	21.6	21.2	22.1	22.6	20.7	21.6	21.2	22.1	22.6
x=2H y=12H	20.9	21.8	21.4	22.3	22.9	20.9	21.8	21.4	22.3	22.9
x=4H y=2H	18.2	19.3	18.7	19.7	20.2	18.3	19.3	18.7	19.7	20.2
x=4H y=3H	20.0	20.9	20.5	21.4	22.0	20.0	20.9	20.5	21.4	22.0
x=4H y=4H	20.8	21.6	21.3	22.1	22.7	20.8	21.6	21.4	22.1	22.7
x=4H y=6H	21.5	22.2	22.1	22.8	23.4	21.6	22.3	22.1	22.8	23.4
x=4H y=8H	21.9	22.5	22.5	23.1	23.8	21.9	22.6	22.5	23.1	23.8
x=4H y=12H	22.2	22.8	22.8	23.4	24.0	22.2	22.8	22.8	23.4	24.0
x=8H y=4H	21.2	21.8	21.7	22.4	23.0	21.2	21.8	21.8	22.4	23.0
x=8H y=6H	22.1	22.6	22.7	23.2	23.9	22.1	22.6	22.7	23.2	23.9
x=8H y=8H	22.5	23.0	23.1	23.6	24.3	22.6	23.0	23.2	23.6	24.3
x=8H y=12H	23.0	23.4	23.6	24.0	24.8	23.0	23.4	23.7	24.0	24.8
x=12H y=4H	21.2	21.8	21.8	22.4	23.0	21.2	21.8	21.8	22.4	23.0
x=12H y=6H	22.2	22.6	22.8	23.3	24.0	22.2	22.7	22.8	23.3	24.0
x=12H y=8H	22.7	23.1	23.3	23.7	24.5	22.7	23.1	23.4	23.8	24.5

**Luminaire**

Code DE-0313-ALU  
 Name Plafón TEMPO leds 18W 3000K

**Measur.**

Code CL116A17F019G  
 Name Plafón TEMPO leds 13W 3000K

Luminaire Flux	1346.44 lm	Luminaire Power	18.80 W	Efficacy	71.62 lm/W	Efficiency	100.00%
Lamps Flux	1346.44 lm	Maximum value	300.54 cd/klm	Position	C=0.00 G=0.00	CG	Double Symmetrical

Diam=350mm

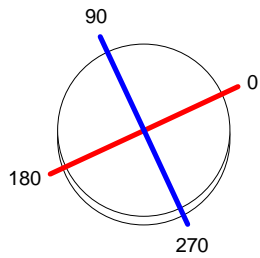

C Halfplanes

180.0 ———— 0.0  
 270.0 ———— 90.0

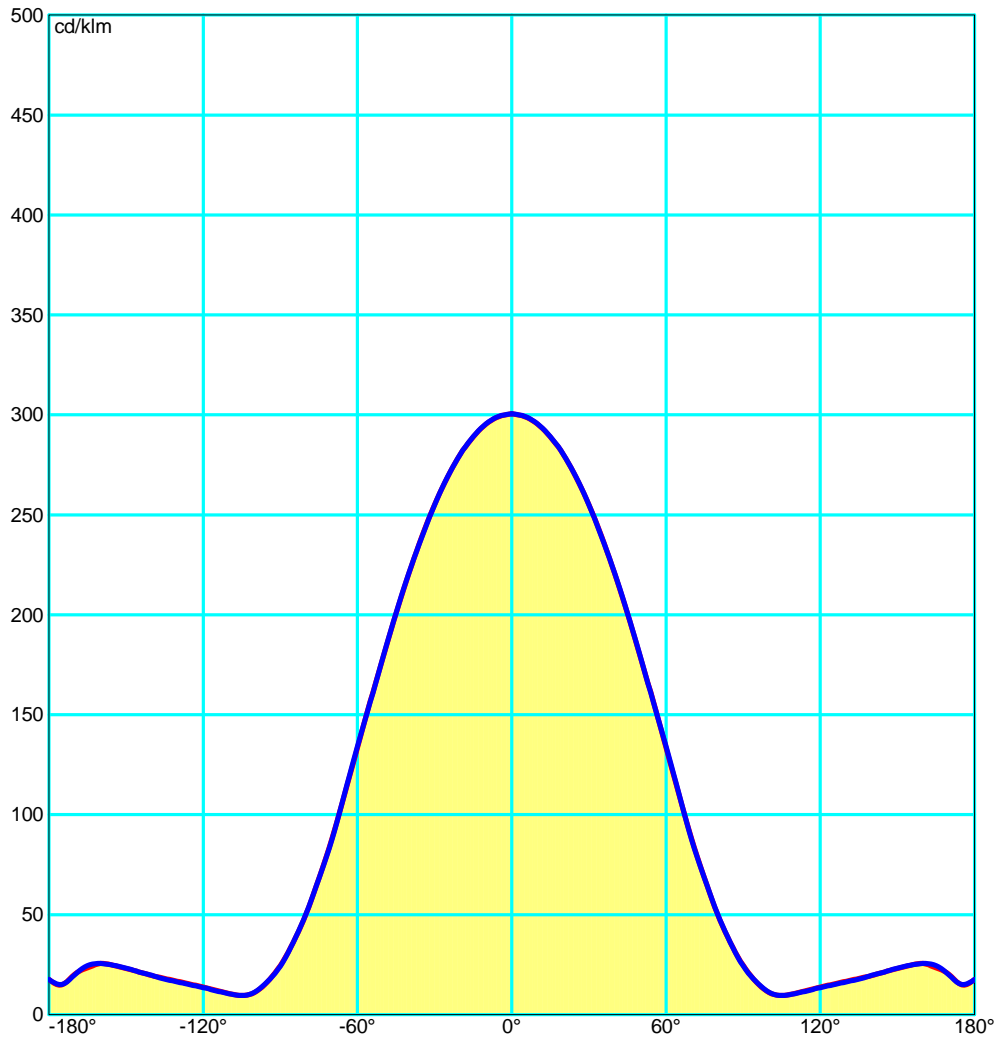

**Luminaire**

Code DE-0313-ALU  
 Name Plafón TEMPO leds 18W 3000K

**Measur.**

Code CL116A17F019G  
 Name Plafón TEMPO leds 13W 3000K

Luminaire Flux	1346.44 lm	Luminaire Power	18.80 W	Efficacy	71.62 lm/W	Efficiency	100.00%
Lamps Flux	1346.44 lm	Maximum value	300.54 cd/klm	Position	C=0.00 G=0.00	CG	Double Symmetrical

Luminance

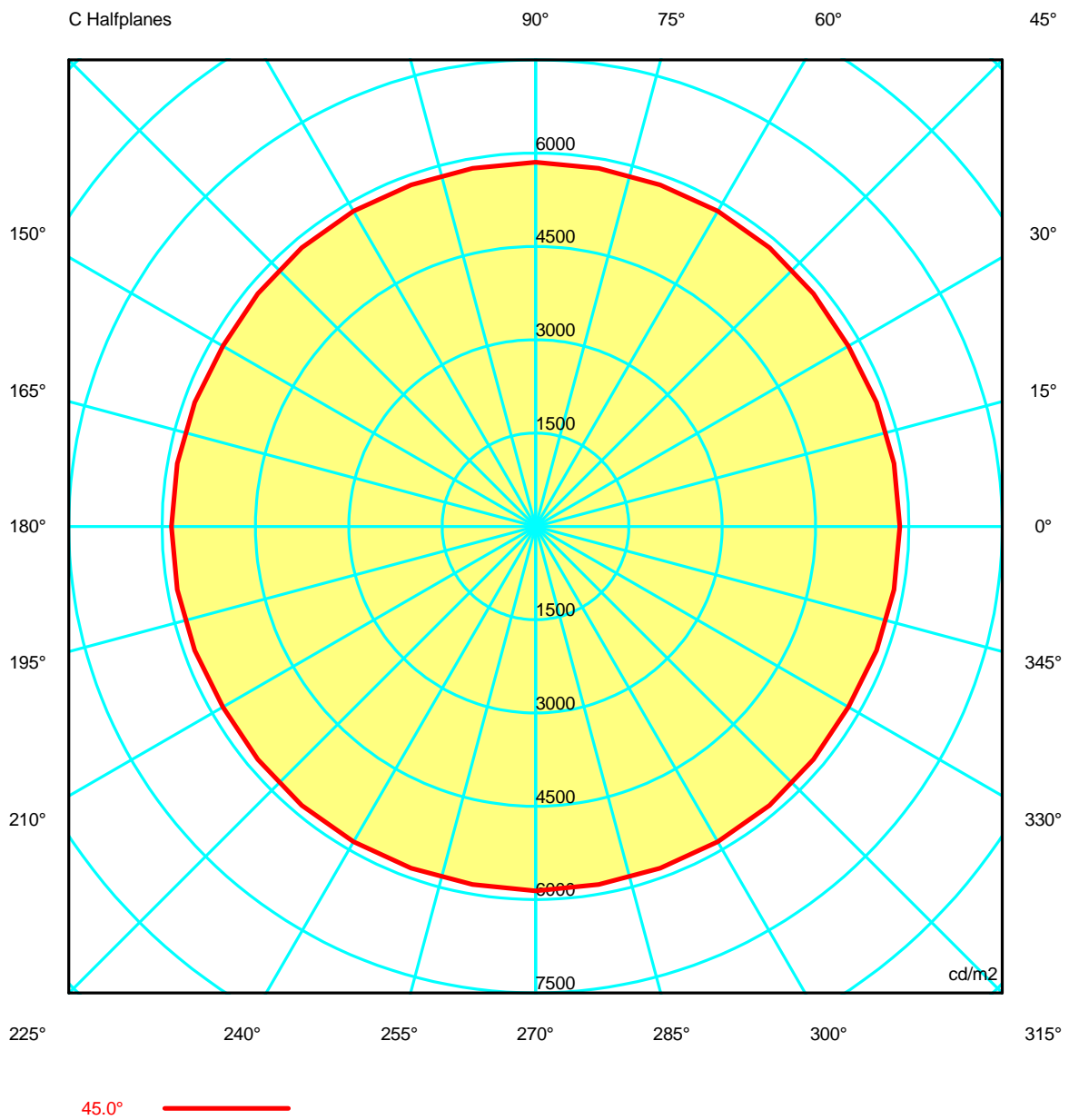



**Luminaire**

Code DE-0313-ALU  
Name Plafón TEMPO leds 18W 3000K

**Measurerm.**

Code CL116A17F019G  
Name Plafón TEMPO leds 13W 3000K

Luminaire Flux	1346.44 lm	Luminaire Power	18.80 W	Efficacy	71.62 lm/W	Efficiency	100.00%
Lamps Flux	1346.44 lm	Maximum value	300.54 cd/klm	Position	C=0.00 G=0.00	CG	Double Symmetrical

**Luminance cd/m2 Table 1/3**

	C 0.00	C 10.00	C 20.00	C 30.00	C 40.00	C 50.00	C 60.00	C 70.00	C 80.00	C 90.00	C 100.00	C 110.00	C 120.00
G 0.0	7067.44	7067.44	7067.44	7067.44	7067.44	7067.44	7067.44	7067.44	7067.44	7067.44	7067.44	7067.44	7067.44
G 5.0	6973.98	6976.60	6977.49	6977.65	6978.05	6977.96	6977.13	6976.56	6976.71	6977.44	6976.71	6976.56	6977.13
G 10.0	6881.19	6881.48	6881.80	6881.48	6880.05	6880.49	6882.72	6883.64	6883.93	6884.36	6883.93	6883.64	6882.72
G 15.0	6779.02	6779.98	6780.78	6780.81	6779.68	6779.78	6780.70	6779.97	6780.59	6783.57	6780.59	6779.97	6780.70
G 20.0	6669.07	6671.49	6672.12	6668.89	6662.16	6662.27	6668.26	6668.44	6668.75	6669.19	6668.75	6668.44	6668.26
G 25.0	6540.35	6541.36	6538.44	6535.26	6539.25	6543.32	6544.01	6544.33	6543.87	6542.47	6543.87	6544.33	6544.01
G 30.0	6401.63	6392.26	6393.82	6398.63	6390.23	6389.61	6399.14	6398.67	6398.29	6400.44	6398.29	6398.67	6399.14
G 35.0	6242.55	6238.55	6234.55	6233.99	6240.00	6241.72	6237.48	6235.96	6236.35	6236.89	6236.35	6235.96	6237.48
G 40.0	6056.44	6049.11	6050.03	6052.58	6035.39	6038.04	6059.44	6057.92	6057.17	6063.30	6057.17	6057.92	6059.44
G 45.0	5850.21	5847.28	5830.16	5804.50	5824.85	5850.01	5853.18	5846.30	5845.80	5855.33	5845.80	5846.30	5853.18
G 50.0	5607.66	5579.81	5590.50	5613.23	5589.97	5589.81	5619.68	5612.44	5606.74	5612.84	5606.74	5612.44	5619.68
G 55.0	5347.60	5345.08	5334.06	5317.51	5327.74	5341.94	5344.89	5342.12	5338.95	5337.19	5338.95	5342.12	5344.89
G 60.0	5035.70	4989.52	5008.01	5044.42	4998.94	4993.19	5044.14	5041.05	5040.93	5060.04	5040.93	5041.05	5044.14
G 65.0	4700.96	4721.53	4676.91	4622.63	4675.59	4712.48	4717.49	4702.42	4701.45	4714.04	4701.45	4702.42	4717.49
G 70.0	4343.04	4306.50	4321.22	4349.72	4313.07	4311.42	4357.32	4358.70	4337.32	4318.09	4337.32	4358.70	4357.32
G 75.0	4053.00	4040.58	4004.39	3959.77	4004.46	4051.81	4052.52	4038.26	4035.54	4048.68	4035.54	4038.26	4052.52
G 80.0	3783.91	3751.28	3774.43	3797.13	3722.33	3722.95	3809.86	3806.76	3797.37	3794.05	3797.37	3806.76	3809.86
G 85.0	3732.56	3732.07	3709.70	3676.00	3713.56	3730.82	3725.03	3735.02	3742.99	3734.03	3742.99	3735.02	3725.03
G 90.0	4098.29	4032.39	4075.36	4138.43	4045.20	4036.66	4138.68	4128.45	4071.03	4029.31	4071.03	4128.45	4138.68



**Luminaire**

Code DE-0313-ALU  
Name Plafón TEMPO leds 18W 3000K

**Measurment**

Code CL116A17F019G  
Name Plafón TEMPO leds 13W 3000K

Luminaire Flux	1346.44 lm	Luminaire Power	18.80 W	Efficacy	71.62 lm/W	Efficiency	100.00%
Lamps Flux	1346.44 lm	Maximum value	300.54 cd/klm	Position	C=0.00 G=0.00	CG	Double Symmetrical

**Luminance cd/m2 Table 2/3**

	C 130.00	C 140.00	C 150.00	C 160.00	C 170.00	C 180.00	C 190.00	C 200.00	C 210.00	C 220.00	C 230.00	C 240.00	C 250.00
G 0.0	7067.44	7067.44	7067.44	7067.44	7067.44	7067.44	7067.44	7067.44	7067.44	7067.44	7067.44	7067.44	7067.44
G 5.0	6977.96	6978.05	6977.65	6977.49	6976.60	6973.98	6976.60	6977.49	6977.65	6978.05	6977.96	6977.13	6976.56
G 10.0	6880.49	6880.05	6881.48	6881.80	6881.48	6881.19	6881.48	6881.80	6881.48	6880.05	6880.49	6882.72	6883.64
G 15.0	6779.78	6779.68	6780.81	6780.78	6779.98	6779.02	6779.98	6780.78	6780.81	6779.68	6779.78	6780.70	6779.97
G 20.0	6662.27	6662.16	6668.89	6672.12	6671.49	6669.07	6671.49	6672.12	6668.89	6662.16	6662.27	6668.26	6668.44
G 25.0	6543.32	6539.25	6535.26	6538.44	6541.36	6540.35	6541.36	6538.44	6535.26	6539.25	6543.32	6544.01	6544.33
G 30.0	6389.61	6390.23	6398.63	6393.82	6392.26	6401.63	6392.26	6393.82	6398.63	6390.23	6389.61	6399.14	6398.67
G 35.0	6241.72	6240.00	6233.99	6234.55	6238.55	6242.55	6238.55	6234.55	6233.99	6240.00	6241.72	6237.48	6235.96
G 40.0	6038.04	6035.39	6052.58	6050.03	6049.11	6056.44	6049.11	6050.03	6052.58	6035.39	6038.04	6059.44	6057.92
G 45.0	5850.01	5824.85	5804.50	5830.16	5847.28	5850.21	5847.28	5830.16	5804.50	5824.85	5850.01	5853.18	5846.30
G 50.0	5589.81	5589.97	5613.23	5590.50	5579.81	5607.66	5579.81	5590.50	5613.23	5589.97	5589.81	5619.68	5612.44
G 55.0	5341.94	5327.74	5317.51	5334.06	5345.08	5347.60	5345.08	5334.06	5317.51	5327.74	5341.94	5344.89	5342.12
G 60.0	4993.19	4998.94	5044.42	5008.01	4989.52	5035.70	4989.52	5008.01	5044.42	4998.94	4993.19	5044.14	5041.05
G 65.0	4712.48	4675.59	4622.63	4676.91	4721.53	4700.96	4721.53	4676.91	4622.63	4675.59	4712.48	4717.49	4702.42
G 70.0	4311.42	4313.07	4349.72	4321.22	4306.50	4343.04	4306.50	4321.22	4349.72	4313.07	4311.42	4357.32	4358.70
G 75.0	4051.81	4004.46	3959.77	4004.39	4040.58	4053.00	4040.58	4004.39	3959.77	4004.46	4051.81	4052.52	4038.26
G 80.0	3722.95	3722.33	3797.13	3774.43	3751.28	3783.91	3751.28	3774.43	3797.13	3722.33	3722.95	3809.86	3806.76
G 85.0	3730.82	3713.56	3676.00	3709.70	3732.07	3732.56	3732.07	3709.70	3676.00	3713.56	3730.82	3725.03	3735.02
G 90.0	4036.66	4045.20	4138.43	4075.36	4032.39	4098.29	4032.39	4075.36	4138.43	4045.20	4036.66	4138.68	4128.45



**Luminaire**

Code DE-0313-ALU  
Name Plafón TEMPO leds 18W 3000K

**Measurment**

Code CL116A17F019G  
Name Plafón TEMPO leds 13W 3000K

Luminaire Flux	1346.44 lm	Luminaire Power	18.80 W	Efficacy	71.62 lm/W	Efficiency	100.00%
Lamps Flux	1346.44 lm	Maximum value	300.54 cd/klm	Position	C=0.00 G=0.00	CG	Double Symmetrical

**Luminance cd/m2 Table 3/3**

	C 260.00	C 270.00	C 280.00	C 290.00	C 300.00	C 310.00	C 320.00	C 330.00	C 340.00	C 350.00
G 0.0	7067.44	7067.44	7067.44	7067.44	7067.44	7067.44	7067.44	7067.44	7067.44	7067.44
G 5.0	6976.71	6977.44	6976.71	6976.56	6977.13	6977.96	6978.05	6977.65	6977.49	6976.60
G 10.0	6883.93	6884.36	6883.93	6883.64	6882.72	6880.49	6880.05	6881.48	6881.80	6881.48
G 15.0	6780.59	6783.57	6780.59	6779.97	6780.70	6779.78	6779.68	6780.81	6780.78	6779.98
G 20.0	6668.75	6669.19	6668.75	6668.44	6668.26	6662.27	6662.16	6668.89	6672.12	6671.49
G 25.0	6543.87	6542.47	6543.87	6544.33	6544.01	6543.32	6539.25	6535.26	6538.44	6541.36
G 30.0	6398.29	6400.44	6398.29	6398.67	6399.14	6389.61	6390.23	6398.63	6393.82	6392.26
G 35.0	6236.35	6236.89	6236.35	6235.96	6237.48	6241.72	6240.00	6233.99	6234.55	6238.55
G 40.0	6057.17	6063.30	6057.17	6057.92	6059.44	6038.04	6035.39	6052.58	6050.03	6049.11
G 45.0	5845.80	5855.33	5845.80	5846.30	5853.18	5850.01	5824.85	5804.50	5830.16	5847.28
G 50.0	5606.74	5612.84	5606.74	5612.44	5619.68	5589.81	5589.97	5613.23	5590.50	5579.81
G 55.0	5338.95	5337.19	5338.95	5342.12	5344.89	5341.94	5327.74	5317.51	5334.06	5345.08
G 60.0	5040.93	5060.04	5040.93	5041.05	5044.14	4993.19	4998.94	5044.42	5008.01	4989.52
G 65.0	4701.45	4714.04	4701.45	4702.42	4717.49	4712.48	4675.59	4622.63	4676.91	4721.53
G 70.0	4337.32	4318.09	4337.32	4358.70	4357.32	4311.42	4313.07	4349.72	4321.22	4306.50
G 75.0	4035.54	4048.68	4035.54	4038.26	4052.52	4051.81	4004.46	3959.77	4004.39	4040.58
G 80.0	3797.37	3794.05	3797.37	3806.76	3809.86	3722.95	3722.33	3797.13	3774.43	3751.28
G 85.0	3742.99	3734.03	3742.99	3735.02	3725.03	3730.82	3713.56	3676.00	3709.70	3732.07
G 90.0	4071.03	4029.31	4071.03	4128.45	4138.68	4036.66	4045.20	4138.43	4075.36	4032.39

**Luminaire**  
 Code DE-0313-ALU  
 Name Plafón TEMPO leds 18W 3000K  
**Measur.**  
 Code CL116A17F019G  
 Name Plafón TEMPO leds 13W 3000K

Luminaire Flux	1346.44 lm	Luminaire Power	18.80 W	Efficacy	71.62 lm/W	Efficiency	100.00%
Lamps Flux	1346.44 lm	Maximum value	300.54 cd/klm	Position	C=0.00 G=0.00	CG	Double Symmetrical

**PERCENTAGE ISOCANDLES**

Projection: Equal Area SLI 6.8 Tight Tilting Angle:0°

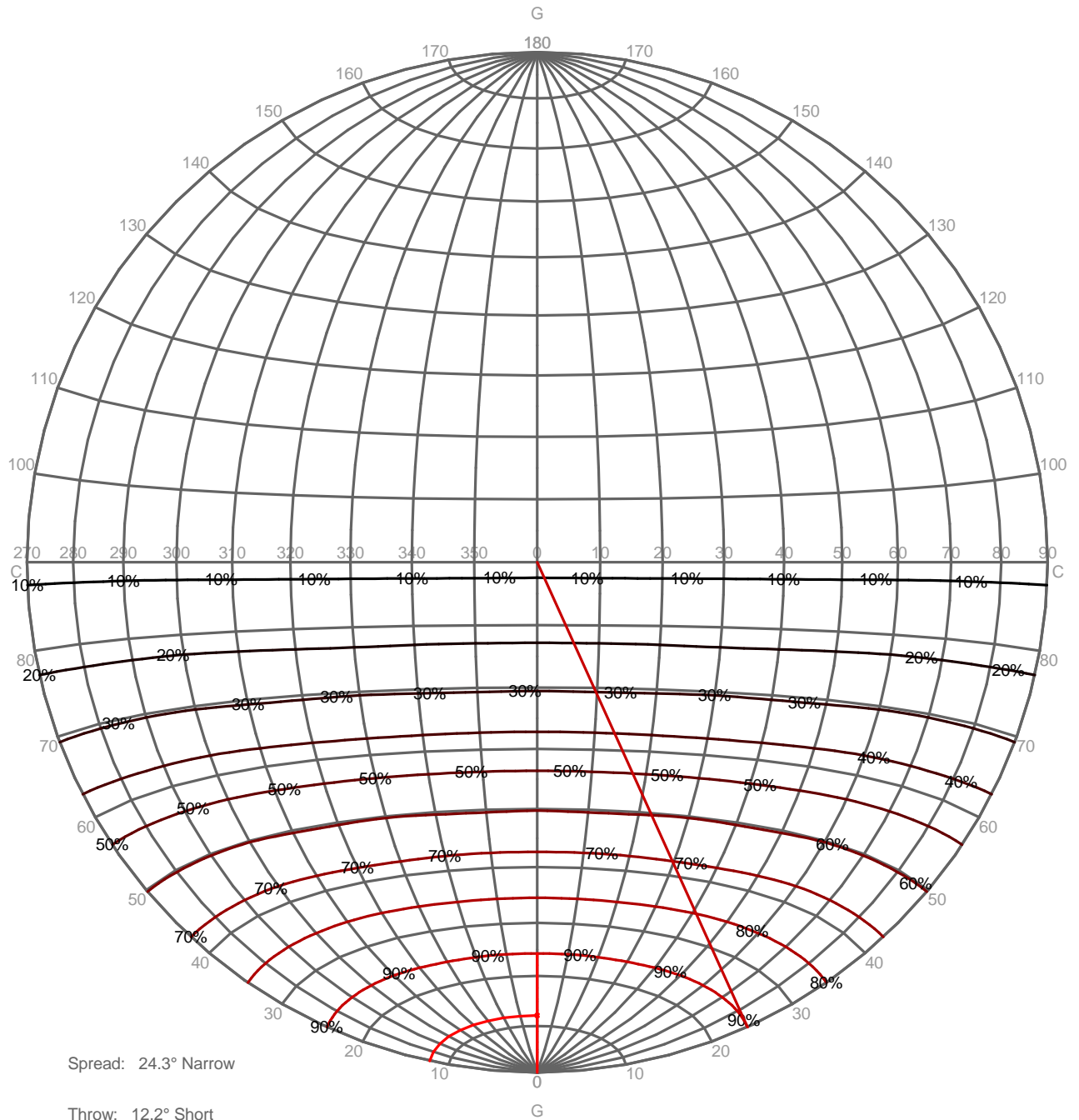

**Luminaire**

Code DE-0313-ALU  
 Name Plafón TEMPO leds 18W 3000K

**Measurement**

Code CL116A17F019G  
 Name Plafón TEMPO leds 13W 3000K

Luminaire Flux	1346.44 lm	Luminaire Power	18.80 W	Efficacy	71.62 lm/W	Efficiency	100.00%
Lamps Flux	1346.44 lm	Maximum value	300.54 cd/klm	Position	C=0.00 G=0.00	CG	Double Symmetrical

Isolux (Floor)

Luminaire position X=0.00m Y=0.00m Z=2.50m

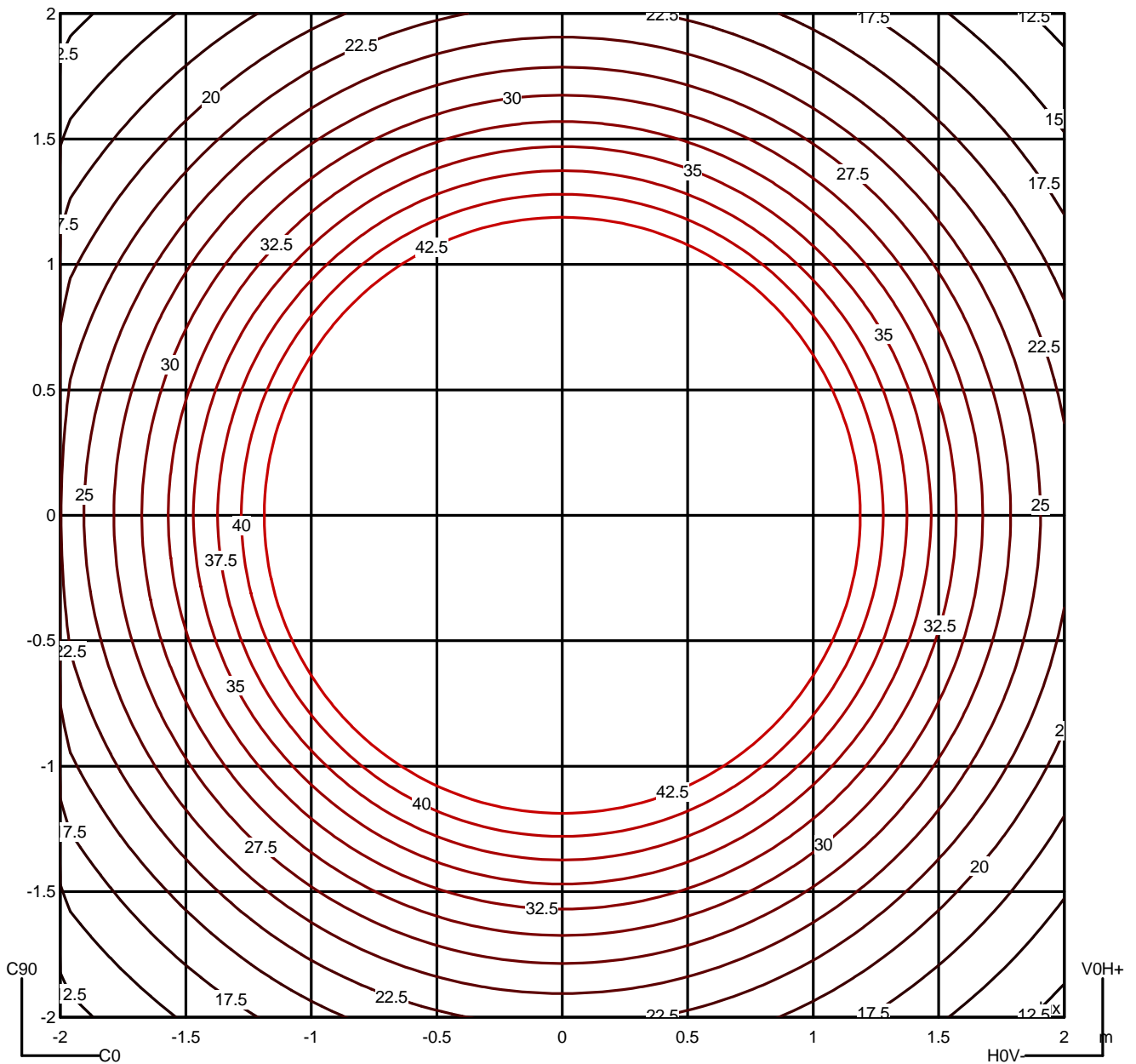

**Luminaire**

Code DE-0313-ALU  
 Name Plafón TEMPO leds 18W 3000K

**Measurment**

Code CL116A17F019G  
 Name Plafón TEMPO leds 13W 3000K

Luminaire Flux	1346.44 lm	Luminaire Power	18.80 W	Efficacy	71.62 lm/W	Efficiency	100.00%
Lamps Flux	1346.44 lm	Maximum value	300.54 cd/klm	Position	C=0.00 G=0.00	CG	Double Symmetrical

		Average Luminance [cd/m <sup>2</sup> ]									
		45°	50°	55°	60°	65°	70°	75°	80°	85°	
0.0°	5850	5608	5348	5036	4701	4343	4053	3784	3733	---	
90.0°	5855	5613	5337	5060	4714	4318	4049	3794	3734	---	

Flush mounted or longitudinal view												
		Illumination(lx)										
A	A	2000	1000	750	500		<300				1.15	
B	1		2000	1500	1000	750	500	<300			1.5	
C					2000		1000	500	<300		1.85	
D	2						2000	1000	500	<300	2.2	
E	3							2000	1000	500	<300	2.55

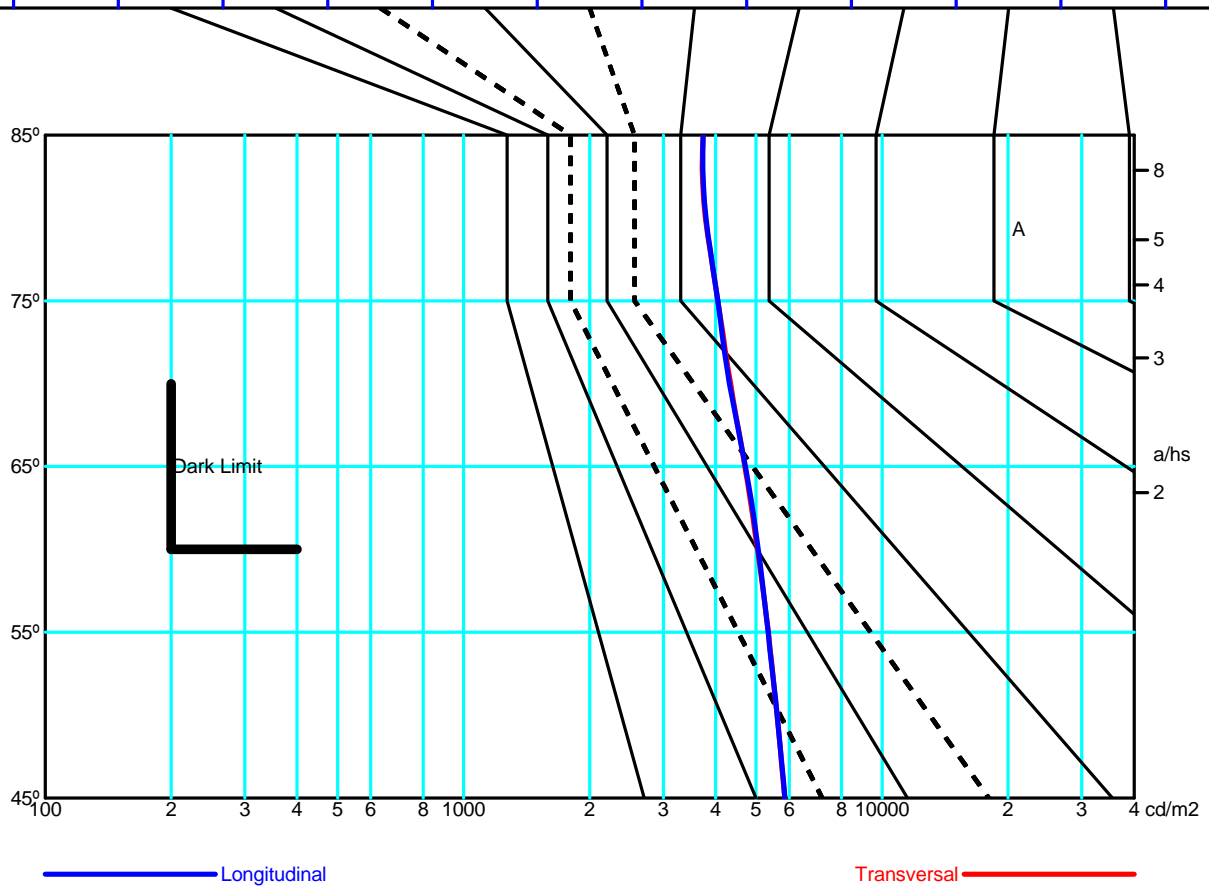

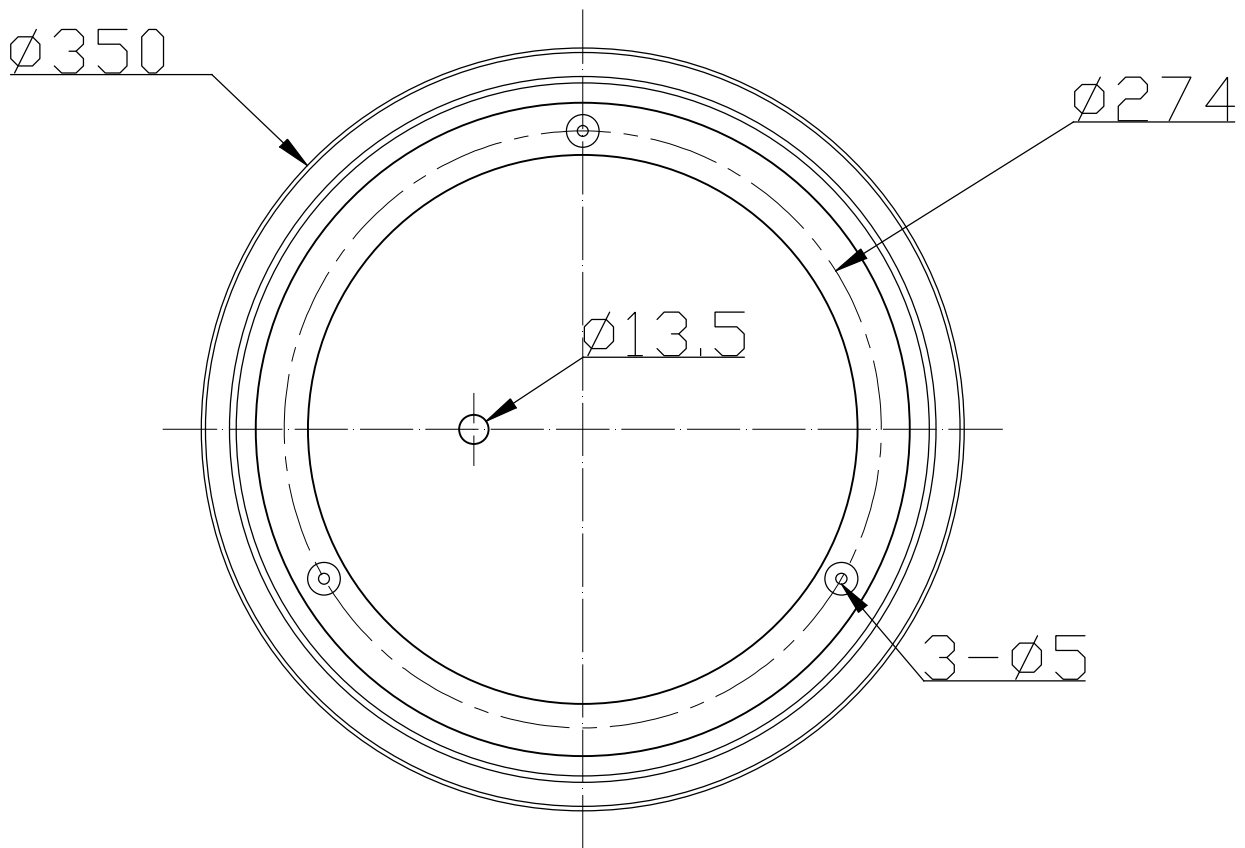
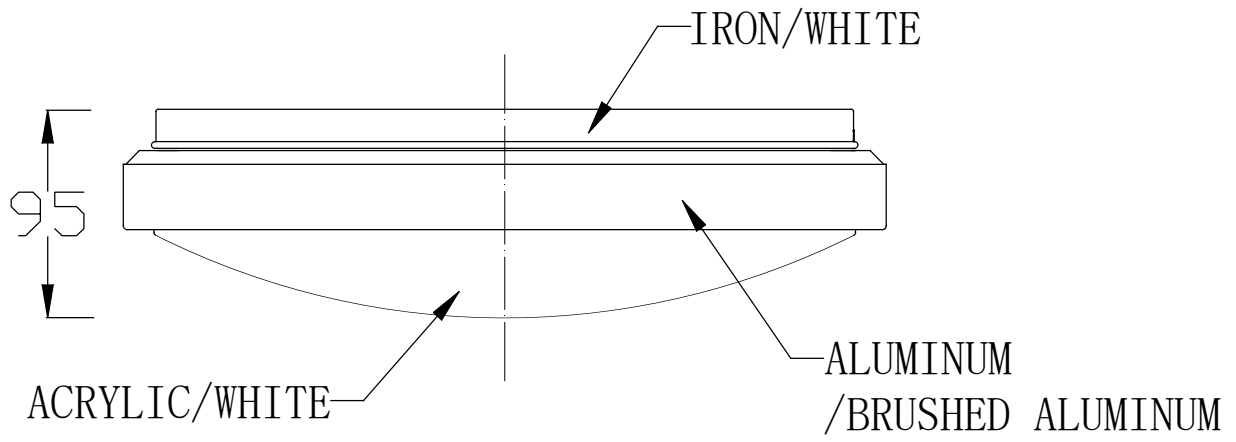



# Tempo

DE-0313 DE-0314

FOR  
LIGHT

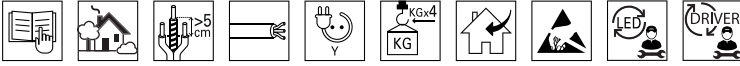

DE-0314

